

OPEN UNIVERSITY &
WATER AUTHORITY AA AND MAAS



Waterschap
Aa en Maas



Open Universiteit
www.ou.nl

The effect of thermal energy
recovery on the ecology of a small,
slow flowing freshwater ecosystem

A modelling approach

IN PARTIAL FULFILLMENT FOR THE DEGREE OF
MASTER OF SCIENCE IN ENVIRONMENTAL SCIENCES

Author

M.W.N. Ramaker, 851868470

Supervisors

S. Boesten - Supervisor Open University

M. van Roij - Supervisor water authority Aa & Maas

W. Ivens - Examiner

's-Hertogenbosch, August 16, 2020

Preface

The thesis that lays or shines -if it is on your computer screen- in front of you is entitled 'the effect of thermal energy recovery on the ecology of a small slow flowing freshwater ecosystem'. It was written in commission of water authority Aa and Maas and it is her contribution to the 'Greendeal Aquathermie' which has the objective of developing and sharing knowledge regarding large scale application of Hydro Thermal Energy (HTE) in the Netherlands.

The first reason for undertaking this research and writing this thesis however, is the Master's program Environmental Sciences at the Open University in which I have invested quite some time since the end of 2015. My motivation to follow this program was, and still is, creating synergy between people and the environment, supported by technology. The research behind this thesis, I think, is a beautiful example of working towards such a synergy in which people, supported by HTE technology, get a comfortable warm home without harming the natural environment.

It has been a very educational research and I have seen many enthusiastic, involved and interested people who, one way or another have the intention to make the world a better and sustainable place. One of the most important people during this research was Stef Boesten. Once a month you provided me with the trust, enthusiasm, necessary critical notes and humor that kept me going. The winner in critical notes however, was Wilfried Ivens; thank you very much for all the constructive remarks that formed this thesis, for the cup of coffee at the 'kickoff' and of course for the other courses. During the Master's program I have also met Angelique Lansu, Dennis Uit de Weerd, Joop de Kraker and Paquita Perez Salgado. You have been very inspiring teachers to me and you deserve an applause for your dedication in educating people in the field of sustainability.

Within water authority Aa and Maas I want to thank (the sharp eyes of) Maaïke van Roij for seeing the opportunity for, and points for improvement in, this research and Paul Bos for providing me with the job that enabled me to perform this research alongside many other inspiring sustainability driven (waste) water projects. Furthermore, the encouragement and the constructive feedback of Maarten Nederlof and the support and curiosity of Bram Spierings, Edith Roelofs, Djamo van der Krabben, Sanne Relou and Koen Dorn amplified my enthusiasm in performing this research.

A lot of my appreciation goes out to the people I met at Deltares. The experience, involvement and feedback of Pascal Boderie and Rick Wortelboer have played a very important role. Besides, Ronald Roosjen and Ida de Groot have encouraged me by acknowledging the value of this research and the meetings with Gerben van der Geest helped me in the startup phase. From Frank Collas, researcher at the Radboud University, I received essential information and future inspiration, for the ecological analysis. Thank you!

The inspiration that made me decide to go for a master title came from some open minded academic nerds who showed me how fascinating the world of sciences is. When I say 'mechatronics' they will know who I mean. I want to say thanks to two academic friends in particular. Tim Assman, you gave me the Python course and a lorry full of enthusiasm that made this whole research possible. Menno Lauret, as a system analyst you understood the challenges of my research, you monitored my progression and by being available in the background you gave me the confidence to finalize this.

In the end one of the most important things in a person's life, to be able to accomplish higher goals and dreams, is the support of family. For example, the support I get from my brothers, Antoine and Rog r, by laughing at me when it comes to vegetarian eating habits which actually disguises that they care about me and that they will be there when I need them. Just like my little sister Val rie, busy with adolescent things but careful when needed. I am happy to be your brother! I am very grateful for all the love and admiration my mother gave me; the endless persistence and eagerness I received from my father; the calm but priceless support of Ronald and the good care of Wilma. I realize that I am fortunate with the immeasurable amount of love from Oma Ditje. And I am thankful for the wisdom and encouragement of Oma Boot who showed me the beauty and importance of books. Your grateful laugh is engraved in my memory forever.

My biggest fan in the last years turns out to be Balou. He was always around and has given me more attention than I sometimes could handle; with his nails in my arm, begging for food; walking over my keyboard kindly asking for a pet over his cheek; but also curled next to me on the couch with his head on the edge of my laptop telling without words that he supports me as long as necessary.

Finally, the most important person I want to thank, how also brought Balou in my life, is Melita. My beautiful girlfriend who I love dearly. The last couple of years haven't been easy at all. But we have kept on walking and the best thing has yet to come. I am proud of you and the things you have accomplished so far. Not only finalizing your education and finding your new job but even more important, the person you have become. I want to thank you with all of my heart for the mountains of love you give me whether I am happy, tired or busy with thinking. And thank you for the same love you put in the delicious food that you make and with which you snared me. Volim te!

Maurice Ramaker

's-Hertogenbosch, March 23, 2021

Abstract

The Netherlands is searching for alternative technologies for heating the built environment to reduce gas mining activities under the province of Groningen and to reduce the emission of greenhouse gasses. Recovery of thermal energy from small (maximum 20 *m* wide and 3 *m* deep), slow flowing (maximum 10 m^3/s) fresh surface water ecosystems (stream) with Hydro Thermal Energy (HTE) can be such a technology.

This thermal energy recovery results in cold water discharge that affects the temperature of a stream which can subsequently influence the biological activity, and thus the ecology in a stream both positively and negatively. Since biodiversity loss is also a major global environmental problem one should avoid the negative effects and enhance the positive effects on the ecology. Therefore, it is important to know to what extent the ecology of a stream is affected by thermal energy recovery with HTE. To come to this knowledge a dynamic model, with a selection of thermal influence characteristics and ecological indicators, has been built to generate insight in the annual interaction between HTE and the stream ecology.

The thermal characteristics describe the whole of thermal energy demand and the thermal influence on the stream. The incoming thermal energy in the stream is the first characteristic. With the extracted thermal energy (cold water discharge) as the central characteristic we determined the resulting temperature of the stream; the longitudinal range of the thermal influence along the stream and the available thermal energy for the built environment.

The ecological indicators were selected because they have a direct quantifiable relation with (changing) temperature, quantifying literature was available and they cover multiple trophic levels. The general thermal water quality score was based on general water quality classifications as a function of the temperature of a stream. The fish spawning potential is based on a time (over a year) window and a temperature window at which a fish species, present in the Dutch fresh surface water, is able to spawn. With a Species Sensitivity Distribution based on temperature, the Potentially Not Occurring Fraction of freshwater bivalves could be determined.

A hypothetical case based on a stream called the Goorloop near Helmond, the Netherlands, with two HTE-system configurations, has been applied in this model. The outcome, which varies considerably due to variation in the flow of the stream, is the size of the thermal influence:

- a) The temperature decreases with 1.15 up to 18.1 °C
- b) The longitudinal range is 0.5 up to 10 *km*
- c) The available thermal energy for the built environment is 22 up to 44 *TJ*

By calculating the status of these ecological indicators with the daily temperature before and after (resulting temperature) HTE, the annual effect of cold water discharge by HTE on the ecology is:

- a) The general thermal water quality score increased with 1%;
- b) The fish spawning potential decreased with 1 up to 24%;
- c) The potentially not occurring fraction of bivalves increased with 35 up to 108%

This research can form the base for future research for both specific cases and generic guidelines for thermal energy recovery from a stream with HTE. The model can be developed further with additional ecological indicators and present stressors, a more accurate longitudinal range and more advanced thermal energy recovery strategies. Besides, more streams and longer time frames could be applied.

We conclude that HTE affects the ecology of a stream both positively (early summer) and negatively (late winter and spring) and that the developed model can help identify the moments in time at which these effects occur.

Contents

Preface	i
Abstract	iii
1 Introduction	1
1.1 Thermal energy recovery from water	1
1.2 Current developments	4
1.3 Problem description	5
1.3.1 Ecological effects of thermal influence	5
1.3.2 Cold water discharge in the Netherlands	6
1.3.3 Key problem	8
1.4 Objective	8
1.5 Research questions	8
2 Methods	10
2.1 Basic assumptions and scope	11
2.1.1 Assumptions	11
2.1.2 In scope	11
2.1.3 Out of Scope	12
2.2 General model components	13
2.3 Thermal characteristic definition	13
2.4 Assembly of the model: thermal analysis	14
2.4.1 Incoming thermal energy	15
2.4.2 Extraction of thermal energy	15
2.4.3 Resulting ecosystem temperature	15
2.4.4 Longitudinal range	16
2.4.5 Available thermal energy for built environment	18
2.4.6 Quantifying data	19
2.5 Ecological indicator selection	20
2.6 Assembly of the model: Ecological analysis	22
2.6.1 Thermal water quality according to WFD	22
2.6.2 Fish Spawning Potential	24
2.6.3 Potentially not Occurring Fraction of Bivalves	25

2.7	Case definition and application	27
2.7.1	Quantifying data: Stream ecosystem	28
2.7.2	Quantifying data: HTE-system with ATES	30
2.8	Programmed model	32
2.9	Verification of the model	33
2.9.1	Expert review	33
2.9.2	Random check	33
2.9.3	Sensitivity	34
3	Results	36
3.1	Size of thermal influence	36
3.2	Ecological indicators: status and effect	40
3.2.1	General thermal water quality score	40
3.2.2	Fish spawning potential	44
3.2.3	Potentially not Occurring Fraction of Bivalves	48
4	Discussion and conclusion	52
4.1	Discussion	52
4.1.1	Model	52
4.1.2	Case	54
4.1.3	Results	54
4.1.4	Value of conclusions	55
4.1.5	Base for further research	55
4.2	Conclusion	56
5	Recommendations	58
	References	59
	Appendix	63
	A Future development of global temperature	64
	B Water types according to the WFD	65
	C Relation between research questions and method	66

D Spawning temperatures and moments	68
E Weather station Eindhoven properties	69
F Case data ecosystem	70
G Communicative Model	71
H Lambda results	78
I Temperature sensitivity analysis results	79
I.1 Size of thermal influence	79
I.2 Thermal water quality score	79
I.3 Fish spawning potential	79
I.4 Bivalve PNOF	79
Glossary	82

1 Introduction

Humankind stands for one of its biggest challenges in its history. The latest reports of the Intergovernmental Panel on Climate Change (IPCC) and the Intergovernmental Science-Policy Platform on Biodiversity and Ecosystem Services (IPBES) show that the global climate is heating up due to anthropogenic greenhouse gas (GHG) emission (IPCC, 2018) and that biodiversity is under heavy pressure due to anthropogenic interference in ecosystems (IPBES, 2019). Climate change is resulting in melting and shrinking ice caps and glaciers. One will experience more extreme weather conditions with more and higher peaks in rainfall and drought and the sea level will rise. Moreover, 1 of the 8 million species on earth are on the edge of extinction as a result of reducing quality of ecosystems (IPBES, 2019). Herewith the ecosystem services they provide are at risk.

Governmental organizations have a big responsibility in solving the global warming problems. This was acknowledged by a substantial amount of parties all over the world by subscribing the Paris Agreement on the 5th of October 2016 (United Nations, 2016). Burning fossil fuels such as oil, natural gas and coal, is an important source of GHG emission in the form of CO₂ and contributes considerably in global warming (IPCC, 2018). For this reason the use of fossil fuels should be reduced substantially.

The Netherlands mine natural gas from the largest gas field of Europe underneath the Dutch province of Groningen. The Netherlands is highly dependent on this natural gas both for heating the built environment and on the income from trade (Vlek, 2019). However, the mining activities also result in earthquakes which have increasing negative impact, ranging from damage to buildings to stress-related health problems, on thousands of inhabitants of this region.

One may conclude that alternative technologies for heating the built environment are required. Technologies that are not based on fossil fuels and do not negatively affect the quality of ecosystems. This research treats thermal energy recovery from water, which could be such an alternative technology. Figure 1 visualizes the place of this technology in the context of the discussed environmental problems and the relationship with the topics that will be discussed in the following subsections of this introduction.

1.1 Thermal energy recovery from water

Thermal energy recovery from water could be a technology that supplies heat (and/or cold) to the built environment (STOWA, 2018c) based on renewable resources. It extracts thermal energy from surface water (de Graaf et al., 2008; Idsø & Årethun, 2017) and/or sewerage water systems (Meggers & Leibundgut, 2011; Frijns, Hofman, & Nederlof, 2013; Dürrenmatt & Wanner, 2014; Inayat & Raza, 2019) and is currently being adopted in the Netherlands. CE Delft and Deltares (2018) and de Boer, Scholten, Boderie, and Pothof (2015) estimated the

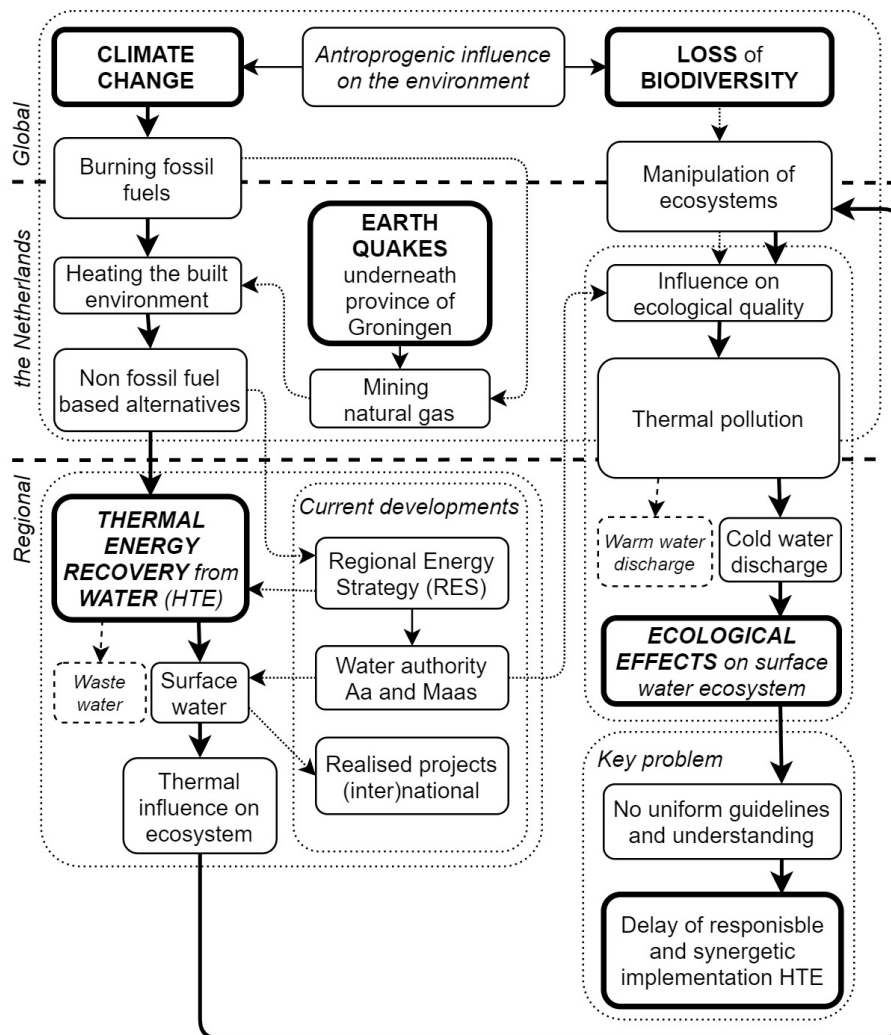

Figure 1: Sketch of the problem context and description of this research. Bold text are key aspects. The thick arrows resemble the main problem line. Dotted arrows complement the context by assigning the secondary aspects. Italic text resembles a paragraph in the introduction or problem description.

theoretical potential of thermal energy from surface water¹ at 43% (150PJ) and from waste water at 16% (56PJ) of the total² (350PJ) heat requirement of the built environment of the Netherlands. This means that, a substantial reduction in use of natural gas and CO₂ emission could be reached since considerable less energy from fossil fuels is needed to produce this thermal energy. This research will focus on thermal energy recovery from surface water.

A variety of names is used for recovery of thermal energy from water. In Dutch the term *aquathermie* is generally accepted, comparable to *aquathermy* in French. However, in english Water-thermal Energy Production System (WEPS) is used by Idsø and Årethun (2017). Deltares (n.d.) and IF Technology (n.d.-b) use the expression *energy from surface water* and *hydro-thermal energy* is used by IF Technology (n.d.-a). The latter is also used by Jagusztyn (2011) for a principle comparable with *ocean thermal energy conversion* which was invented by Claude around 1930 (Chiles, 2009). For this research we will use the term hydro-thermal energy (HTE) and we define it as: extraction of thermal energy from a surface water system.

For extraction of the thermal energy from a surface water system one guides the water (partly) through or alongside a heat exchanger. This heats up the medium of a heat pump system that flows through a separate circuit of the heat exchanger. Due to a difference in temperature between the systems, thermal energy can be exchanged through the heat exchanger. The thermal energy in the heat pump system is then transported to the (collective) heat distribution system in the built environment. The cooled down surface water remains in, or is pumped back into, the surface water ecosystem.

It is still possible to extract heat from the surface water if the temperature is lower than ten degrees Celsius. From an efficiency of energy generation point of view a higher temperature of the surface water is more advantageous. However, thermal energy requirement of the built environment is highest in winter season. This contradiction is called seasonal counter-cyclical differences and to overcome this a thermal energy storage system is used. The most commonly used storage system in the Netherlands is an Aquifer Thermal Energy Storage system (ATES) where thermal energy is stored in a water containing layer (aquifer) in the ground. However, an artificial drilled well can also be applied and is called a Borehole Thermal Energy Storage system (BTES). The surface water system and the water of the thermal storage system are kept separate. In figure 2 the explained working principle is depicted.

As a result of the extraction of thermal energy from the surface water system the temperature of the surface water will decrease³. This can be seen as anthropogenic manipulation of an ecosystem and since temperature influences rates of biological activity (Dodds & Whiles, 2010) it could influence the ecology in it.

¹Under the condition that district heating and ATES is applied and surface water and thermal energy user are within range of 5km of each other.

²Required thermal energy in 2050, after application of thermal energy saving measures in the coming decades.

³It is also possible to use the same heat pump system for cooling the built environment. In that case the medium in the heat pump system is warmer than the surface water at place of the heat exchanger. The surface water will heat up due to uptake of thermal energy from the heat pump system.

Since influence on the ecology could have negative influence on the biodiversity these effects should be taken into account when designing and applying HTE-systems (STOWA, 2018c). In this study we make a start with this.

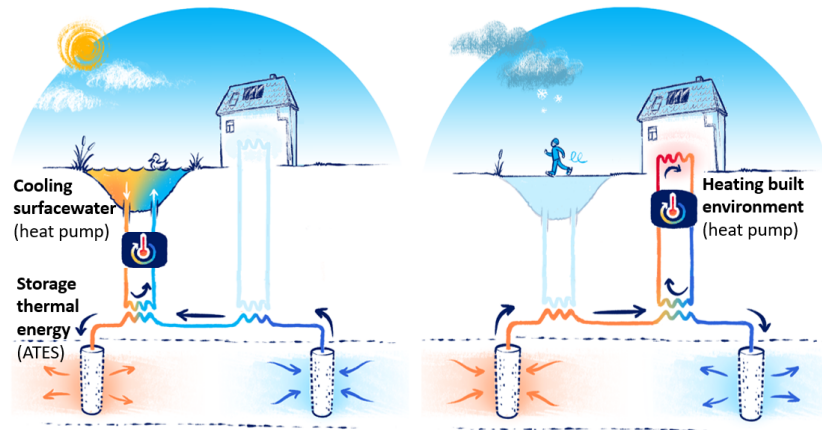

Figure 2: Hydro Thermal Energy (HTE) working principle, modified from Waternet (2019). The surface water is cooled by the heat pump system and the recovered thermal energy is stored in an ATES. Later on the stored thermal energy is recovered from the ATES, the temperature is increased by the heat pump system and heat is delivered to the built environment. In this cycle only heat is exchanged between water bodies not the water itself.

1.2 Current developments

HTE is not an entirely new technology. In Norway an HTE-system in a fjord is providing 30 GWh of thermal energy to the surrounding built environment (Idsø & Arethun, 2017). In their review on district cooling systems Inayat and Raza (2019) sum up several examples of hydro-thermal energy systems in China, Hong Kong, Stockholm and Hawaii that use seawater for cooling the built environment. In the Netherlands 66 HTE projects (Netwerk Aquathermie, 2020a) have been realized in combination with surface water. This way several thousand homes are heated with HTE. Driven by the Regional Energy Strategy (RES), the national and integral decarbonisation vision, and the Transition Vision Warmth, regional governmental organisations are now exploring the possibility of using the full potential from HTE. The objective of the national government is to decrease the CO₂ emission with 95%, compared to 1990, by 2050. All regions that published their strategies (20/30) at the moment of writing consider HTE as an important local source of sustainable thermal energy (Netwerk Aquathermie, 2020b).

The Dutch water authorities are responsible for governance related to water. They originate from local collaborations that build the first dikes well before the 13th century and organized surface water level control. Now they are divided over 21 regions with the primary task of establishing and maintaining the water quality as described in the Water Framework Directive (WFD) and

managing the water level to protect all inhabitants from flooding and maintaining a water level high enough for nature and agricultural processes. As HTE is directly related to the surface water systems managed by the water authorities they are involved with the development and application of this technology. HTE can help decreasing their own use of natural gas and GHG emission and the water authorities want to facilitate the Dutch society in doing so. However, they also have concerns regarding the application of HTE and the possible effect on the surface water ecology. A negative influence would be in conflict with one of their primary tasks: establishing and maintaining a proper surface water quality. Moreover it would be in conflict with solving the global problem of biodiversity loss. This research addresses this concern by investigating the potential influence of HTE on the surface water ecology.

1.3 Problem description

In surface water systems water temperature is one of the most important environmental factors for rates of biological activity (Dodds & Whiles, 2010) of, among others, freshwater fish (Leuven et al., 2011; Whitehead, Wilby, Battarbee, Kernan, & Wade, 2009) and bivalves (Verbrugge, Schipper, Huijbregts, van der Velde, & Leuven, 2012). As explained above, HTE influences the water temperature and the thermal balance in the surface water system⁴. Thereby HTE could have considerable influence on the ecology of surface water ecosystems. Although the application of HTE could lead to a reduction of GHG emission one should prevent negative effects on the surface water ecology.

1.3.1 Ecological effects of thermal influence

According to 'the guideline for HTE' of STOWA (2018b) both positive and negative effects on the ecology can result from thermal influence by HTE. Table 1 provides an overview of some examples of these potential effects which will be discussed below. We categorize these in positive and negative effects on the ecology meaning respectively enhancing or decreasing (the support for) interaction between organisms and their biophysical environment.

A decrease in temperature could have positive effects on the aquatic ecology such as a reduction in dominance of blue algae (van der Grinten et al., 2007). Moreover, the negative effects that come with climate change such as more and longer periods with lethal high temperatures and anaerobe conditions (Alterra, 2007), could be limited if thermal energy is extracted from the water (STOWA, 2017a) with HTE⁵. In figure 3 an increase of both water and air temperature as a result of climate change can be observed. A further increase of these temperatures can be expected in the future (IPCC, 2013) as can be seen in appendix A. An increase in water temperature limits the chemical saturation of dissolved

⁴The water temperature is never static and there is always thermal interaction (heating up or cooling down) with several environmental factors. If the water temperature changes the balance in this interaction changes.

⁵Off course these effects could also be enhanced if thermal energy is added in the case HTE is used for cooling the built environment and no ATEs is applied.

Table 1: Possible effects of thermal influence on aquatic ecology. Examples for both positive and negative effects of temperature increase and decrease with respect to the nominal temperature. '+' means an incline of the aspects and '-' means a decline of the aspect. Upper limit is defined in existing guidelines, lower limit has still to be determined.

	Negative ecological effect	Positive ecological effect
Temp. increase	<ul style="list-style-type: none"> + sensitivity for toxic substances¹ - dissolved oxygen¹ + competition position of exotic species^{1,2} 	<ul style="list-style-type: none"> + metabolism and growth of organisms
Temp. decrease	<ul style="list-style-type: none"> - metabolic process of fish³ - growth rate of juvenile fish³ + mortality of juvenile fish⁴ - distribution of fish⁴ - activity of fish⁴ 	<ul style="list-style-type: none"> + dissolved oxygen⁵ - blue algae dominance¹ - botulism risk⁵

Sources: 1) van der Grinten et al. (2007), 2) Whitehead et al. (2009), 3) Lugg and Copeland (2014), 4) Astles, Winstanley, Harris, and Gehrke (2003), 5) STOWA (2017b)

oxygen in water which leads to lower oxygen concentrations. At the same time the increase in water temperature can lead to lower oxygen concentrations due to an increase in biomass production which leads to more detritus produced and a higher demand of oxygen from mineralization processes (personal communication, R. Wortelboer, June 8, 2020). Moreover, higher water temperature can result in an increase in exotic species (Whitehead et al., 2009; van der Grinten et al., 2007), increased sensitivity of organisms for toxic substances and an increased risk for botulism van der Grinten et al. (2007).

However, negative effects in ecological water quality are also reported in case of lowering the water temperature. Lugg and Copeland (2014) observed a decrease in the metabolic processes and growth rate of fish and an increase in mortality of juvenile fish in a review on cold water pollution impacts on biological processes of aquatic organisms. In the case of cold water pollution below the Burrendong Dam in an Australian river Astles et al. (2003) found that juvenile native fish grew considerably less than the ones under natural temperatures. In the same study a reduction in survival, distribution and activity of these fish were observed.

1.3.2 Cold water discharge in the Netherlands

The national tool developed for the assessment of ecological consequences of thermal pollution in rivers (RIVM, n.d.) is only suited for warm water discharge and not for cold water discharges. The RIVM advises to limit warm water discharge to 3 °C with an absolute thermal limit of 28 °C (van der Grin-

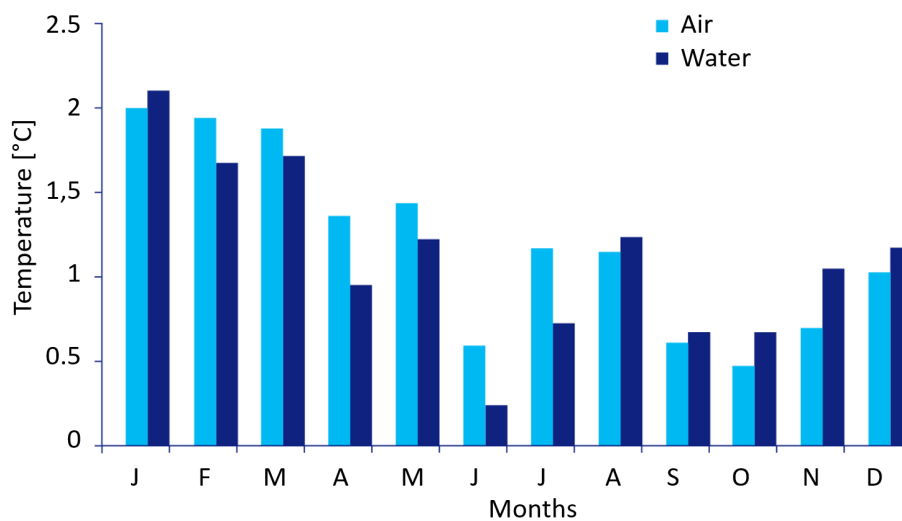

Figure 3: The average increase of air and water temperature in the period of 1988-2006 with respect to 1887-1961. Modified from (STOWA, 2011). Air temperature was based on KNMI measurements. Mooij et al. (2007) modeled the water temperature based on the IJsselmeer (lake) in the Netherlands.

ten et al., 2007). However, no legal and regulatory framework on temperature decrease is available and also no other guidelines regarding cold water discharge are available within the Netherlands (van Megchelen, 2017; STOWA, 2017a; de Boer et al., 2015).

It was concluded by Boderie, van Geest, and van Megchelen (2018) that, at this moment, it is not possible to learn from practice about the influence of cold water discharge by HTE on the ecological water quality in general due to a limited amount of available (measurement) data. Theoretical research of Boderie and Wortelboer (2018) shows that the ecological effect of cold water discharge by HTE-systems is negligible when applied to large fast (up to 700 m^3/s) flowing water systems such as the river Rhine and Meuse. However, the category small and slow flowing rivers (up to 10 m^3/s) such as the Roer and the Aa and stationary water systems are relatively vulnerable for cold water discharge due to the limited water volume. Therefore, there is a medium to high risk of thermal and ecological effects and further research is required. For this reason, the emphasis of this research will lay on cold water discharge in small, slow flowing surface waters of the Netherlands. From now on called streams.

Until this moment only one study has been performed on the ecological effects of cold water discharge by HTE on a shallow freshwater body in the Netherlands (van Megchelen, 2017; Wortelboer, 2018). This study took place in Hoog Dalem (Gorinchem, the Netherlands) where a HTE-system extracts heat from a shallow surface water between half June and half September by decreasing the temperature of 150 m^3 water per hour with 3-5 °C. A reduced production of algae was observed but no significant changes in specie assembly and presence was measured (Wortelboer, 2018).

1.3.3 Key problem

It is expected that, due to the high energetic potential of HTE, there will be a substantial increase in HTE-systems in the Netherlands in the coming years. However, uniform rules and guidelines for the discharge of cold water to streams are absent at this moment. In combination with the limited understanding of the ecological effects of the cold water discharge this delays a responsible and synergetic implementation of HTE in especially streams. Therefore, it is necessary to gain better insight in the ecological effects of cold water discharge in streams.

1.4 Objective

The objective of this research is to contribute to the understanding in the effect of the cold water discharge of a HTE-system on the ecology in streams ecosystems. This is done by development of a model. This model calculates the effect on several ecological indicators of streams after the deployment of a hypothetical HTE-system. The developed computer model forms a basis for further research and a more advanced model. The results from the analysis, regarding the effect on the ecology, help the Dutch water authorities in the development of a governance structure to assess new HTE inquiries. Based on the obtained information about ecological degradation risks and potential synergetic ecological enhancement opportunities, the water authorities can make better informed decisions on the implementation of HTE.

1.5 Research questions

The main research question that needs to be answered with the model we developed is **to what extent is the ecology of a streams affected by thermal energy recovery with HTE?** The sub-questions which correlate to the construction and application of the model and which should lead to answering the main research question are:

1. Which characteristics, that describe the thermal interaction between thermal energy recovery with HTE and a stream ecosystem, have a significant influence on the thermal balance of the ecosystem?
2. What is the size of the thermal (influence) characteristics, as a result from thermal energy recovery by HTE?
3. Which ecological indicators can be used for quantification of the effects of cold water discharge on the ecology of stream ecosystems?
4. What is the status of the ecological indicators before and after cold water discharge by HTE?

The order of answering the questions is schematically depicted in figure 4. Determination of the characteristics that describe the thermal interaction between

the HTE-system and the stream ecosystem is essential to formulate an answer on the size of the cold water discharge. By combining this with a set of ecological indicators that are temperature dependent we are able to determine the status of the ecology. Both the cold water discharge and the current and new ecological status can provide us with an indication of the resulting effect of a HTE-system on the ecology of a stream ecosystem.

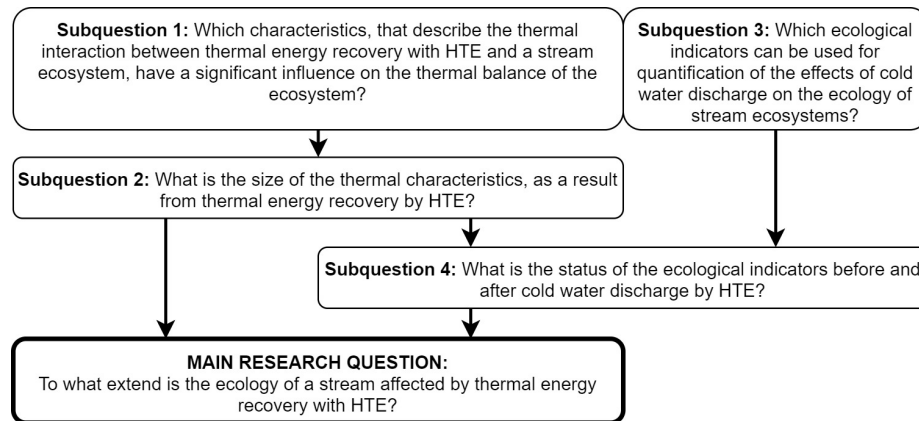

Figure 4: Research question tree

2 Methods

In this chapter we will explain the steps taken in this research that lead to the assembly of the model, which we use to analyze the potential effect of cold water discharge from HTE on the ecology of a stream ecosystem. In figure 5 the relationship between these steps is depicted. In appendix C the relation between the research questions and the method parts is depicted. The assembly of the model plays a central role and it was designed with the predefined general model components. To come to the model we firstly defined the characteristics and specifications that describe the thermal interaction between the stream ecosystem and the HTE-system. Thereafter, we defined the ecological indicators that can be used for quantifying the effect on the ecology.

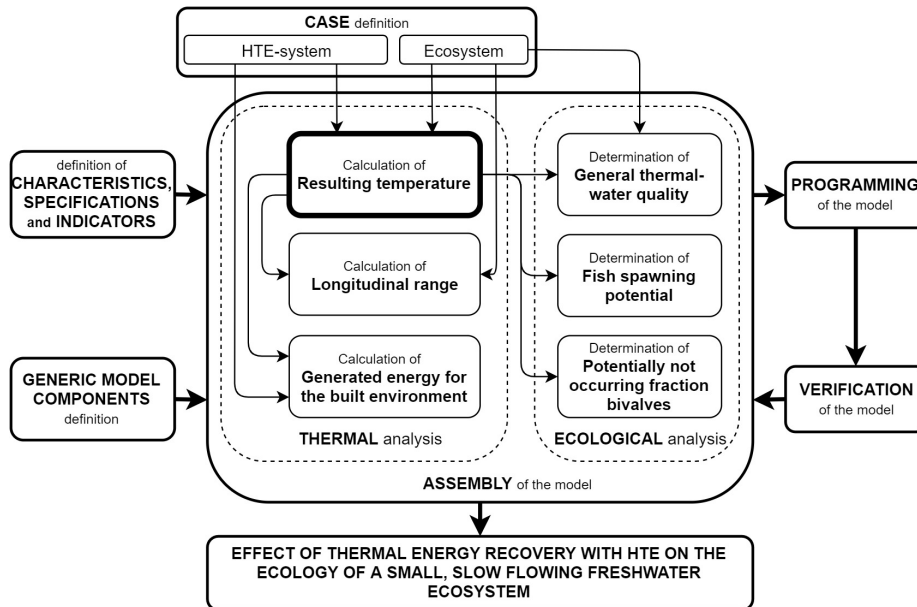

Figure 5: Diagram describing the relationship between the main aspects of the applied methods in this research. The calculation of the resulting temperature forms the base for all other calculations.

The model was split in a thermal part and an ecological part. After several iterations of assembly, programming and verification of these parts, the model was used to generate insight in the effect of the cold water discharge on the ecology by running it with a specific case. The definition of this case was split in a HTE-system and a stream ecosystem part. It is described separately from the thermal and ecological model parts to make the model generic applicable with other cases in the future. The selected thermal characteristics and ecological indicators are already depicted in figure 5 to provide the reader with an overview while reading this chapter. A description of the programmed model and an explanation of the verification process will end this chapter.

2.1 Basic assumptions and scope

Before starting to explain how the model was built and how the analysis was performed we will treat the main assumptions and the scope in more detail.

2.1.1 Assumptions

Temperature influences biological processes (Dodds & Whiles, 2010), therefore we assume that HTE will have effect on the ecology of a stream. Ecosystems are very complex but we deem that by the use of several ecological indicators we can get insight in the effect cold water discharge from HTE has on the ecology of a stream as a whole. Moreover, many aspects of an HTE-system and the context in which it is applied can vary considerably. In this research we assume that:

- a) *The assembly of the HTE-system* in the context of the total thermal energy solution looks like as depicted in figure 6b
- b) *Thermal influence from cold water discharge is considered at a cross-section in the stream as depicted in figure 6a*
- c) *Temperature (change) is homogeneously divided over the cross-section of the stream*
- d) *Water flow is constant through both the stream and the HTE-system over a day*

For the specific case treated in this research:

- a) *Temperature of the stream* was based on historic measurement data
- b) *Water flow through the stream* was based on historic measurement data
- c) *Water flow through the HTE-system* is:
 - half of the water flow through the stream (Configuration 1)
 - average of the water flow through the stream (Configuration 2)

2.1.2 In scope

The following aspects define what is within the scope of this research:

- a) *Stream (ecosystem)*: The geometric definition of Wortelboer (2018) for a slow flowing small fresh surface water ecosystem is used: maximum width of 20 meter and a maximum depth of 3 meters and a maximum flow of 2 percentile 10 m³/s.
- b) *Temporal scale*: All seasons will be considered and the time resolution is a day.

- c) *Spatial scale*: This research is applied on streams in the Netherlands.
- d) *WFD water types that are included are*: R4, R19, R5, R6, R7, R12, R20. Appendix B displays an over view of all water types including a short (Dutch) description.

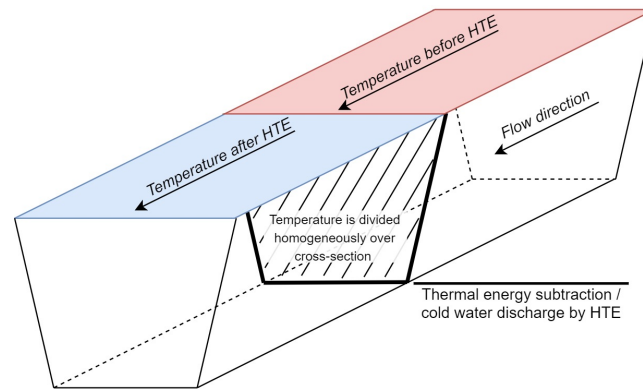

(a) Schematic depiction of the assumed thermal situation.

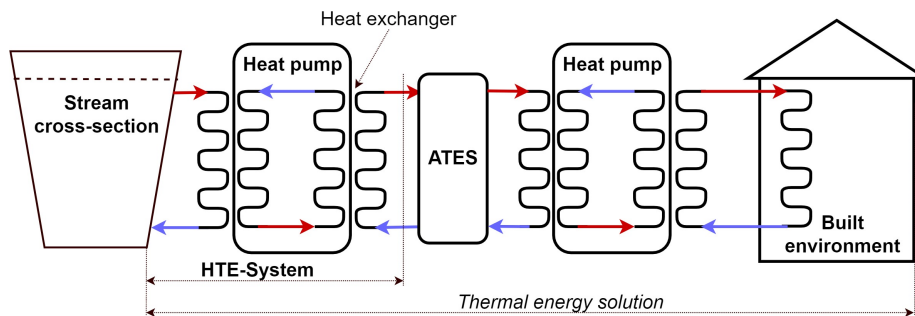

(b) Schematic depiction of the assembly of a HTE-system in the context of a thermal energy solution. Red arrows symbolize relatively warm water flows. Blue arrows symbolize relatively cold water flows. Vertical wavy lines are heat exchangers.

Figure 6: Schematic depiction of system assumptions

2.1.3 Out of Scope

The following items are *excluded* from this research although they may have an effect on the ecology of a stream:

- a) *Cleaning procedures*, with among others ionisation and electrolysis technology, to prevent contamination of the HTE-system.
- b) *Induced flow*, in the stream, generated by the HTE-system.
- c) *Expected climate change effects* on stream temperature.

2.2 General model components

The model is composed out of the standard building blocks depicted and explained further in appendix G. The quantifying data, used for the calculations, deserves some extra explanation. The data in the model can be categorized as follows:

1. Generic thermal data
2. Generic ecological data
3. Stream ecosystem data
4. HTE-system data

Generic thermal and ecological data both quantify the generic components used to set up the model and required for performing the calculations with the model. The thermal data relate to the calculations performed in the thermal analysis and the ecological data relate to the calculations performed in the ecological analysis. These data categories will be explained and filled in under respectively section 2.4 and 2.6. The stream ecosystem data and HTE-system data include all data that quantify the specific case at hand. The content of these parts will be explained in section 2.7.

2.3 Thermal characteristic definition

The natural thermal balance in a stream determines the temperature of the stream and with this a certain biological activity. The amount of heating and cooling of the stream and the amount of movement of the heat in the stream determines this balance and with this the temperature of the water. Temperature increase is the effect of solar radiation, exchange of heat with the atmosphere and natural warm water inputs such as: precipitation, condensation, ground-water and incoming streams and rivers. Temperature decrease is established by back radiation, evaporation and the input of cooler water (Sweers, 1976; Dodds & Whiles, 2010). Moreover, upstream thermal pollution may influence the temperature as well.

The essence of an HTE-system is extracting thermal energy from a stream, with the objective to fulfil a certain thermal energy demand, which results in thermal influence on the stream ecology. Therefore, the thermal characteristics cover the whole of the thermal energy demand and the thermal influence on the source (stream). In figure 7 the defined characteristics are depicted.

Incoming thermal energy [J/day] is the thermal energy available in the stream up to the freezing point of water and was selected because it is the subject that is eventually influenced by HTE.

Extraction of thermal energy [J/day] is the amount of thermal energy that is recovered from the stream by HTE, which is the cold water discharge and thus the influencing factor.

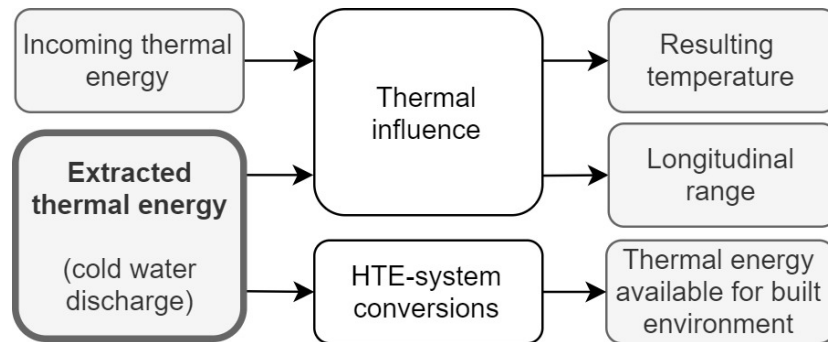

Figure 7: Coherence of the thermal characteristics (in grey) that describe HTE from demand (thermal energy available for built environment) until the thermal influence on the stream ecosystem (resulting temperature and the longitudinal range).

The **resulting temperature** [$^{\circ}\text{C}$] is the outcome of the influence from HTE on the stream and is dependent on the ratio between incoming and extracted thermal energy. This determines the effect on ecological indicators with a temperature dependency, at point of the HTE-system.

The **longitudinal range of thermal influence** [m] is required to specify the size (length) of the part of the stream that is influenced and thus how far the ecological effect could reach. We assume that the cold water discharge of HTE is distributed homogeneously over the stream cross-section (6a) at the HTE-system. In other words, we assume that the output water from the HTE-system is mixed perfectly with the water from the stream. With this, we exclude so called thermal plumes from this research that may have influence on 2D and 3D distribution of the thermal influence.

Energy available for the built environment [J/day] is an essential characteristic as this quantifies the primary function of an HTE-system: fulfilling a certain energy demand.

2.4 Assembly of the model: thermal analysis

In this section we explain how the thermal model was built with the thermal characteristics that were explained in the previous section. The base for the model is illustrated in the communicative model in appendix G. It visualizes how all model elements are connected and 'work' towards (sub)outcomes of the model. The thermal characteristics are divided over three model parts:

- Resulting ecosystem temperature (incl. incoming, and extraction of, thermal energy)
- Longitudinal range
- Available energy for the built environment

2.4.1 Incoming thermal energy

Incoming thermal energy E_{EB} [J/day] refers to the thermal energy as a function of time (t in day) that is present in the stream ecosystem and comes from upstream. E_{EB} was determined with equation 1 in which T_{EB} [$^{\circ}C$] is the temperature of the ecosystem before influence by HTE. We assume that zero degree Celsius is the reference temperature for this calculation. ρ_w and c_w are respectively the density [kg/m^3] and specific heat capacity [$J/(kg \cdot K)$] of freshwater. Qd_E [m^3/day] is the amount of water per day that passes the point of interest in the stream ecosystem and can be calculated with equation 2. In this equation Q_{SE} [m^3/s] stands for the flow of water in the stream ecosystem and t_{day} is the amount of seconds in a day.

$$E_{EB}(t) = T_{EB} \cdot Qd_E \cdot \rho_w \cdot c_w \quad (1)$$

$$Qd_E(t) = Q_{SE} \cdot t_{day} \quad (2)$$

2.4.2 Extraction of thermal energy

The extraction of thermal energy by HTE ($E_{HTE}(t)$ in J/day) from the stream is based on the same principles as E_{EB} and can be calculated with equation 3. In which ΔT_{HTE} is the temperature difference [$^{\circ}C$] between the water inlet and outlet of the HTE-system as function of time (t in day). ρ_w and c_w resemble the density [kg/m^3] and heat capacity [$J/(kg \cdot K)$] of freshwater. $Qd_{HTE}(t)$ [m^3/day] is the water flow through the HTE-system per day and was calculated by the use of equation 4. In this equation $Q_{S_{HTE}}$ [m^3/s] is the water flow through the HTE-system per second and t_{day} is the amount of seconds in a day. For the days on which E_{HTE} is larger than E_{EB} we corrected ΔT_{HTE} so that E_{HTE} is equal to E_{EB} .

$$E_{HTE}(t) = \Delta T_{HTE} \cdot Qd_{HTE} \cdot \rho_w \cdot c_w \quad (3)$$

$$Qd_{HTE}(t) = Q_{S_{HTE}} \cdot t_{day} \quad (4)$$

2.4.3 Resulting ecosystem temperature

We subtracted the thermal energy of HTE (E_{HTE} in J/day) from the incoming thermal energy E_{EB} [J/day] (eq. 5). With this we get the modified amount of thermal energy in the stream after HTE (E_{EA} in J/day). With equation 6 we calculated the resulting temperature of the stream T_{EA} [$^{\circ}C$]. In which Qd_E is the water flow through the stream [m^3/day]. ρ_w and c_w are the same density [kg/m^3] and heat capacity [$J/(kg \cdot K)$] of freshwater as used before. For the days ΔT_{HTE} was corrected, T_{EA} will become zero. For this model it was assumed that the temperature will be distributed homogeneously over the cross-section of the stream that we analyse. T_{EB} and T_{EA} are used to determine the status of the ecological indicators.

$$E_{EA}(t) = E_{EB} - E_{HTE} \quad (5)$$

$$T_{EA}(t) = \frac{E_{EA}}{Qd_E \cdot \rho_w \cdot c_w} \quad (6)$$

In appendix G the communicative model of the incoming energy, extracted energy and the resulting temperature part of the model can be found under: Thermal Analysis - Resulting temperature.

2.4.4 Longitudinal range

With this part of the thermal analysis we provide a first estimation of the distance s_r [m], in longitudinal direction of the stream that the thermal influences reaches. For this we calculated the distance it takes for the stream to recover to the natural thermal balance and with this the temperature before HTE.

The status of the ecological indicators -which will be treated in chapter 2.6- is determined at the point of the cold water discharge. In figure 8 the relationship with the ecological indicators and the other thermal characteristics is explained.

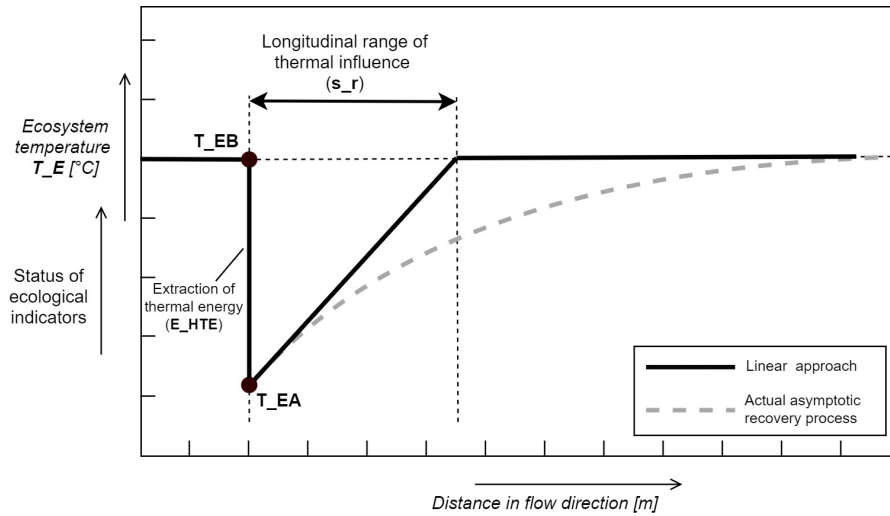

Figure 8: The relationship between the longitudinal range, the ecological indicators and the thermal characteristics. The HTE-system extracts a certain amount of energy from the stream and with this the stream ecosystem temperature decreases from T_{EB} to T_{EA} . Thermal recovery takes place over the longitudinal range until the natural thermal balance is restored and the temperature is back at T_{EB} .

As mentioned in the former subsections we start with the temperature of the stream ecosystem as it is before HTE. Then we extract an amount of energy which results in the lower temperature of the stream after HTE. The status of, and the effect on, the ecological indicators is determined with the temperature

of the stream at the point of extraction of the thermal energy. After this, over a certain distance, the temperature will recover back to the value it was before HTE as a result of heat fluxes from convection, evaporation, radiation from air and back radiation.

With equations 7, 8 and 9, we calculated the net heat exchange flux [$J/m^2/s$] at the water-air interface (ϕ_{tot}) after the energy extracting by HTE. These equations are based on research performed by Sweers (1976) which is still used in prominent water quality modelling software (Deltares, n.d.). In these equations T_{EB} and T_{EA} are the temperature [$^{\circ}C$] of the stream respectively before and after HTE. λ stands for heat exchange coefficient at the water-air interface. $f(U_{10})$ is the wind speed function in which U_{10} is the wind speed [m/s]. a_s is the water surface [m^2] which is one in this application of the equation as we are only interested in heat exchange flux just before and just after HTE.

$$\phi_{tot}(t) = -\lambda \cdot (T_{EA} - T_{EB}) \quad (7)$$

$$\lambda = (4.48 + 0,049 \cdot T_{EA} + f(U_{10}) \cdot (1.12 + 0.018 \cdot T_{EA} + 0.00158 \cdot T_{EA}^2)) \quad (8)$$

$$f(U_{10}) = (3.5 + 2.0 \cdot U_{10}) \cdot \left(\frac{5 \cdot 10^6}{a_s} \right)^{0.05} \quad (9)$$

With equation 10 we assume that the thermal balance of the stream is restored at the moment the energy resulting from the heat exchange flux (ϕ_{tot}) is equal to the energy extracted by HTE (E_{HTE}). Both the surface A [m^2] of the stream and the recovery time t_r [s] are required to come to a certain amount of energy resulting from the heat flux. The surface of the stream is depend on the width of the stream w_E [m] and the longitudinal range s_r [m]. The flow speed v_E [m/s] of the stream and the recovery time t_r are required to calculate the range of the recovery. With this equation we also assume that the heat flux is constant over the recovery time and that the recovery process is linear from energy point of view. In reality however, the heat flux changes as a result of the stream heating up again. Which is a asymptotic process as depicted in figure 8. Therefore, the outcome of this calculation should be interpreted as a first estimation of the order of magnitude of the longitudinal range and certainly not as the actual range.

$$\frac{E_{HTE}}{A \cdot t_r \cdot \phi_{tot}} = \frac{E_{HTE}}{w_E \cdot s_r \cdot t_r \cdot \phi_{tot}} = \frac{E_{HTE}}{w_E \cdot v_E \cdot t_r^2 \cdot \phi_{tot}} = 1 \quad (10)$$

To calculate the recovery time and distance the velocity of the water in the stream v_E [m/s] is required. This was calculated with equation 11. In this equation Qd_E is the daily water flow [m^3/day] through the stream, w_E is the width [m] of the stream and d_E is the depth [m]. f_{ca} is the fraction of the $w_E \cdot d_E$ cross-sectional surface that is filled with water. The time t_r [s] that the recovery

takes is expressed by equation 12 and based on equation 10. Eventually we calculated the longitudinal distance s_r [m] that the recovery takes with equation 13. This is the longitudinal range of the thermal influence.

$$v_E = \frac{Qd_E}{w_E * d_E * f_{ca}} \quad (11)$$

$$t_r(t) = \sqrt{\frac{E_{HTE}}{w_E \cdot v_E \cdot \phi_{tot}}} \quad (12)$$

$$s_r(t) = v_E \cdot t_r \quad (13)$$

In appendix G the communicative model of this part of the model can be found under: Thermal Analysis - Longitudinal range of thermal influence.

2.4.5 Available thermal energy for built environment

To be able to describe the relationship between functional thermal energy⁶ and the effect on the ecology, we determined the amount of energy that can actually be delivered to the built environment after it was extracted with HTE. To this end we needed to take into account the amount of electric energy (from the electrical grid) that is used by the heat pump(s) and which is added as additional thermal energy to the HTE-system. Moreover, for the same end the efficiency of the storage of the thermal energy in the ATES needs to be taken into account. With this we assume that in all cases an ATES is used to store the energy extracted from the stream ecosystem at one moment in time for another moment in time⁷. The coefficient of performance (COP) gives us the fraction of electric energy that was used for the total amount of thermal energy that was delivered by the heat pumps in the HTE-system.

Equation 14 was applied to calculate the COP for the thermal energy extraction from the stream to charge the ATES (COP_{CH}). Equation 15 is used to calculate the COP for the thermal energy extraction from the ATES to deliver it to the built environment and with this discharging the ATES (COP_{DCH}). In these equations T_{EB} stands for the temperature [°C] of the stream ecosystem before HTE. T_{ATES} and T_{BUILT} are respectively the temperature [°C] of the ATES and the built environment. η_{COP} is the ratio between actual COP and the theoretical Carnot efficiency. We assumed this to be 0.6 (personal communication S. Boesten, February 19, 2020). Both equations are based on Knudsen and Petersen (2017).

⁶energy that can be used for heating the built environment

⁷A configuration without a thermal storage system is excluded because it is not possible to deal with the seasonal counter-cyclical differences in thermal energy availability and demand.

$$COP_{CH}(t) = \eta_{COP} * \frac{T_{EB} + 273}{T_{EB} - T_{ATES}} \quad (14)$$

$$COP_{DCH}(t) = \eta_{COP} * \frac{T_{ATES} + 273}{T_{BUILT} - T_{ATES}} \quad (15)$$

In this part of the model, equation 16 is used for calculating the total amount of energy E_{CH} [J/day] with which the ATES is charged per day (t). This is the result of the energy extraction from the stream ecosystem E_{HTE} [J/day] and the COP of the heat pump used for charging the ATES. With equation 17 we calculate the amount of thermal energy that we can discharge from the ATES E_{DCH} [J/day] for use in the built environment. This depends on the efficiency (η_{ATES}) of the ATES.

$$E_{CH}(t) = E_{HTE} * \frac{COP_{CH}}{COP_{CH} - 1} \quad (16)$$

$$E_{DCH}(t) = \frac{E_{CH}(t)}{1 + 1 \cdot \eta_{ATES}} \quad (17)$$

Eventually, the amount of thermal energy that is available for the built environment E_{BUILT} [J/day] can be calculated with equation 18. Again we needed to take into account the COP of the heat pump (COP_{DCH}) that is used for discharging the ATES.

$$E_{BUILT} = E_{DCH} * \frac{COP_{DCH}}{COP_{DCH} - 1} \quad (18)$$

In appendix G the communicative model of this part of the model can be found under: Thermal Analysis - Energy available for built environment.

2.4.6 Quantifying data

In table 2 we list the primary input elements including their quantification and units.

Table 2: Generic quantifying data used in model for the thermal analysis

Symbol	Input element	Quantity	Unit
ρ_w	Water density	998	kg/m ³
c_w	Water specific heat capacity	4180	J/(kg · K)
a_s	Water surface factor	1	m ²

2.5 Ecological indicator selection

We assume that temperature has an effect on the ecology of a stream. Streams are very complex ecosystems however. Through the selection of ecological indicators that have a temperature dependency we assume that we can get insight in the status of the ecology of a stream. With this we also assume that we are able to get insight in the effect of cold water discharge of HTE on the ecology of the stream. The indicators should be **quantifiable** and **quantifying literature** should be available to process them mathematically in the model. Moreover, the ecological indicator should **directly be related to the (changing) temperature** of the stream.

The indicators that have been considered are:

- Macrophytes (Ecological Key Factor)
- Risk for blue algae bloom and/or botulism
- Chemical indicators (dissolved oxygen and/or electrical conductivity)
- General thermal-water quality
- Spawning potential of fish
- Potentially not Occurring Fraction (fish and/or bivalves)

Below we will explain the considerations that were made in the selection of the indicators and the eventual selected indicators. For the latter more background information is provided in section 2.6.

Macrophytes (aquatic plants) need a proper environment to establish and grow and form the conditions for other organisms to do the same. Macrophytes as used in STOWA's Ecological Key Factor (STOWA, 2017a) has been considered as an ecological indicator because it includes a temperature dependency. However, this temperature dependency was not directly based on temperature values but on the amount of shadowing along a stream (STOWA, 2018a)(personal communication, G. van Geest, November 26, 2019). Therefore, a direct link with the calculated temperature values before and after HTE cannot be made and it was not included in the model.

A **blue algae bloom** (Cyanobacteria) is an excessive incline of a specific type of algae population that can have a harmful effect on animals and the ecology. The occurrence of **Botulism** (Clostridium botulinum bacteria) in a stream can lead to intoxication of animals. The **dissolved oxygen** is a direct indicator for the ability of a stream to support aquatic life (EPA, n.d.-b). Although there is a dependency between the risk for occurrence of these bacteria, the dissolved oxygen and temperature, they were not included in the model. The eventual effect of a temperature change on botulism (Espelund & Klaveness, 2014) and blue algae blooms are not only influenced by temperature but even more by chemical-physical ecosystem properties such as pH, nutrient concentration (Lathrop, R. C., Stow, C. A., Panuska, J. C., Soranno, P. A., & Carpenter,

1998) and ecological quality in general (condition of biology, hydromorphology and general physical chemistry (STOWA, 2018d)). The same is valid for dissolved oxygen.

The **conductivity** is the ability of water to pass an electrical current and can be influenced by temperature (EPA, n.d.-a). However, due to the complex correlation with the ecological quality (Brezonik, 1994) it was assumed not useful as a direct ecological indicator for the model at this moment.

The **thermal water quality** classification uses temperature to classify the water quality of a stream (STOWA, 2018d). It is based on WFD guidelines and clearly has a direct dependency with temperature and is quantifiable by means that will be explained in section 2.6. Since it directly expresses the water quality of the stream as a whole as function of temperature it is interesting to include this in the model.

For the **spawning potential of fish** quantifying data with a dependency with temperature are available in literature (van der Grinten et al., 2007). Fish have a relationship with many other aspects of the ecology. They feed on among others insects and plants and they are affected by changing chemical conditions such as dissolved oxygen, acidity and temperature (EPA, n.d.-c). Dodds and Whiles (2010) state that if a fish is able to reproduce it also should have energy to grow and survive. This is visualized in figure 9. Therefore, the temperature and (yearly) time window in which common Dutch freshwater fish species potentially spawn could cover a considerable part of the ecology of a stream. This is why we will use the spawning potential of fish in relation to the changing water temperature as a ecological indicator in this model. In section 2.6.2 this will be explained in more detail.

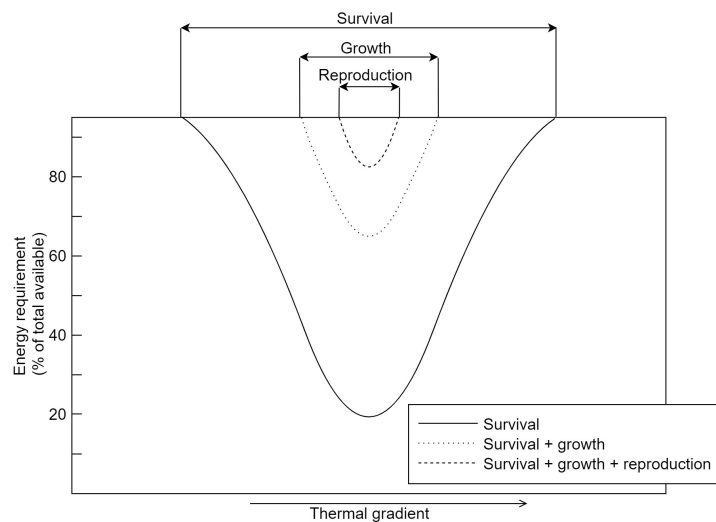

Figure 9: Conceptual visualisation showing the dependency of a fish' required energy for survival, growth, and reproduction as a function of temperature. If a fish requires more than 100% of the energy available in the ecosystem for survival it will not grow. However, if the sum of required energy for survival, growth and reproduction is less than the available energy, reproduction should be possible (Dodds & Whiles, 2010).

A **Species Sensitivity Distribution** (SSD) was described by Leuven et al. (2011) and Verbrugge et al. (2012) as a "statistical distribution that describes the variation between species in sensitivity to an environmental stressor". Temperature can be seen as a stressor and SSDs based on temperature are available for fish (Leuven et al., 2011) and for bivalves (Collas, Buijse, Hendriks, van der Velde, & Leuven, 2018). Quantification of the temperature dependency of fish and bivalves is reasonably simple with the SSDs. Moreover, both SSDs include a considerable amount of species (fish 61, bivalve 30). With this it was assumed that these SSDs could serve as ecological indicators that provide us with insight in the effect of decreasing water temperatures on the ecology. Eventually only the bivalve SSD was selected as the effect on fish species is partly covered by the fish spawning potential. With this SSD we determine the Potentially not Occurring Fraction (PNOF) of bivalves.

For the **overall effect** on the ecology we now make use of an indicator that covers the thermal water quality as a whole. The spawning potential of fish resembles a relatively high trophic level in the food chain of the stream and the SSD of the bivalve species resembles a lower trophic level. This should provide insight in the effect of thermal influences on the ecology of a stream as a whole (personal communication F. Collas, July 31, 2019).

2.6 Assembly of the model: Ecological analysis

In this chapter the assembly of the selected ecological indicators in the ecological part of the model will be explained. The stream ecosystem temperatures (T_{EB} and T_{EA}) from the thermal part of the model serve as primary input elements for the calculations with the ecological indicators. By comparison of the status of the ecological indicators based on T_{EB} with the status of the ecological indicators based on T_{EA} we determined the effect on the stream ecology that result from the cold water discharge by HTE.

Together they enable analysis of the ecological effect of the cold water discharge of HTE.

2.6.1 Thermal water quality according to WFD

From water quality point of view it is not desirable if the temperatures of a stream get too high (or too low). Therefore, within the WFD a classification method was developed with which the water quality per water type can be classified from 'very good' to 'good', 'moderate', 'insufficient' and 'bad' as a function of the stream ecosystem temperature (table 3). As we mentioned in chapter 1.3 until shortly there was no need for guidelines and classification methods for (too) cold water. Therefore, the initial objective was to define the upper temperature limits. Which is the reason that the temperatures in this classification method are based on maximum temperatures.

Therefore, it is not possible to tell something about the negative effect of cold water discharge by HTE. However, by analysing whether the temperature of the ecosystem rises to a higher quality classification under influence of HTE we

Table 3: General water quality related to water temperature [$^{\circ}\text{C}$], supplied with a quality score and divided over WFD water types that comply with our definition of a stream. Modified from (STOWA, 2018d)

Water type	Water quality				
	Very good	Good	Moderate	Insufficient	Poor
R4, R19	<14	<18	18-20	20-22.5	>22.5
R5, R6, R7, R12, R20	<23	<25	25-27.5	27.5-30	>30
Score [QSP]	4	3	2	1	0

can obtain insight in the positive effects of HTE. This also means that if temperatures, under influence of HTE, go below the temperature with the ‘very good’ classification one cannot speak about positive effects anymore. Thus, if HTE forces the stream temperature below the temperatures classified as ‘very good’ this is not rewarded from ecological point of view. This is valuable for water authorities because with this they are able to assess whether a HTE-system really has only the positive effects that some believe it has or whether there is a limit to these positive effects.

To make relative comparison possible between the thermal situation before and after HTE (T_{EB} and T_{EA}) we added a score for each class (see bottom row of table 3). Based on the WFD water type of the stream used for the case, we were able to assign the corresponding temperatures to the scores which is expressed in ‘Quality Score Points’ (QSP). One should be aware of the fact that this score does not tell anything about the absolute quality of the stream and that it is only meant for relative comparison between the thermal situation before and after HTE.

For both the temperatures before and after HTE (T_{EB} and T_{EA}) we determined the daily thermal water quality score according to the values in table 3. The outcome is the quality score in as a function of time (t) in days, before HTE $QS_B(t)$ [QSP] and after HTE $QS_A(t)$ [QSP]. We determined the absolute effect of HTE by subtracting the daily score before HTE from the daily score after HTE which results in a delta score ($\Delta QS(t)$ [QSP]). By dividing the delta score by the score before HTE we get the relative effect (ΔrQS [%]) of HTE on the thermal water quality of the stream.

By taking the sum of all daily quality-scores before HTE and after HTE we get an annual score for both thermal situations; respectively AQS_B and AQS_A [QSP/year]. The absolute effect of HTE ΔAQS [QSP/year] was determined by subtracting the annual quality score before HTE from the annual quality score after HTE. To determine the relative effect $\Delta rAQS$ [%] we divided the absolute annual effect by the annual quality score before HTE.

In appendix G the communicative model of this part of the model can be found under: Ecological Analysis - Thermal water quality score.

2.6.2 Fish Spawning Potential

Research of van der Grinten et al. (2007) delivered an overview of the thermal spawning preferences (appendix D) of the fish species that are present in the Dutch fresh surface waters. This overview includes the moment of the year the fish species can spawn and the temperature limits within they spawn. From this overview we selected the fish species that are expected, and aimed, to be present and preferably to spawn in the investigated stream. Subsequently, in combination with the temperatures of the stream ecosystem before HTE ($T_{EB}(t)$) and after HTE ($T_{EA}(t)$) we can determine whether a fish species is, from thermal and timing point of view, able to spawn⁸. We do this by checking, per day (t) and per fish species (i); is the temperature of the stream ecosystem (T_E) within temperature limits and is the date (t) within the time window of spawning? This approach is visualised in figure 10.

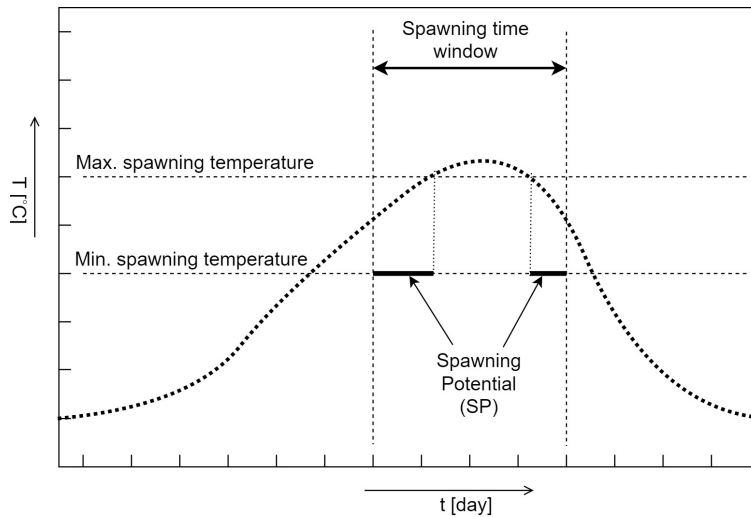

Figure 10: Spawning potential determination per fish species. The solid line resembles a hypothetical temperature curve over a year. All dashed lines resemble the time and temperature limits within a certain fish species is able to spawn. The bold horizontal lines are the resulting moments in time at which spawning is actually possible.

Subsequently, the spawning potential for both the situation before (SP_B) and after HTE (SP_A) was determined by counting the number of fish (N_i) that are able to spawn per day (t) (eq. 19). This is reported as the amount of 'Spawning Potential Days' (SPD). After that, we determined the annual spawning potential per fish species by counting the days on which a fish species (i) is potentially able to spawn in the analysed period (N_t in days) before $ASP_B(i)$ [SPD] and after HTE $ASP_A(i)$ [SPD] (eq. 20). The annual spawning potential before ASP_B [SPD] and after HTE ASP_A [SPD] for all fish species together was calculated (eq. 21) by taking the sum of all potential spawning days of all fish species over the analysed period.

⁸This should not be confused with predicting whether a fish species *will* or *will not* spawn as this depends on many more criteria and parameters than only temperature.

$$SP(t) = \sum_{i=1}^{i=N_i} SP(i, t) \quad (19)$$

$$ASP(i) = \sum_{t=1}^{t=N_t} SP(i, t) \quad (20)$$

$$ASP = \sum_{t=1}^{t=N_t} SP(t) \quad (21)$$

The effect of HTE on the fish spawning potential can now be determined by comparing the amount of potential spawning days for the thermal situation before and after HTE. This was done per day ($SP(t)$) and over the analysed year both in total (ASP) and per fish species ($ASP(i)$). To this end we determined the delta spawning potential [SPD] by subtracting the spawning potential before HTE from the spawning potential after HTE resulting in respectively $\Delta SP(t)$, ΔASP and $\Delta ASP(i)$. Moreover, the relative effect [%] of HTE on the spawning potential was determined by dividing the delta spawning potentials by the spawning potential before HTE, resulting in $\Delta rSP(t)$, $\Delta rASP$ and $\Delta rASP(i)$.

In appendix G the communicative model of this part of the model can be found under: Ecological Analysis - Fish Spawning Potential.

2.6.3 Potentially not Occurring Fraction of Bivalves

Collas et al. (2018) applied the SSD method (introduced in chapter 2.5) to get insight in the sensitivity for temperature on the occurrence of bivalve molluscs in a European freshwater ecosystem. This research resulted in a deviation of Potentially Not Occurring Fraction (PNOF) of the bivalve molluscs as a function of habitat temperature (figure 11). This includes both the lowest (min) and the highest (max) temperature at which a the bivalve species occur. The mean and the standard deviation that form this deviation are summarized in table 4. Together with the temperatures before ($T_{EB}(t)$) and after ($T_{EA}(t)$) HTE these were used to calculate the PNOF [0 – 1] in the model.

Table 4: From the research of Collas et al. (2018) we derived the mean (μ) and standard deviation (σ) for SSD of freshwater bivalves at both minimum and maximum temperature [$^{\circ}C$].

Endpoint	μ [$^{\circ}C$]	σ
Minimum habitat occurrence	6.20	4.29
Maximum habitat occurrence	26.5	4.88

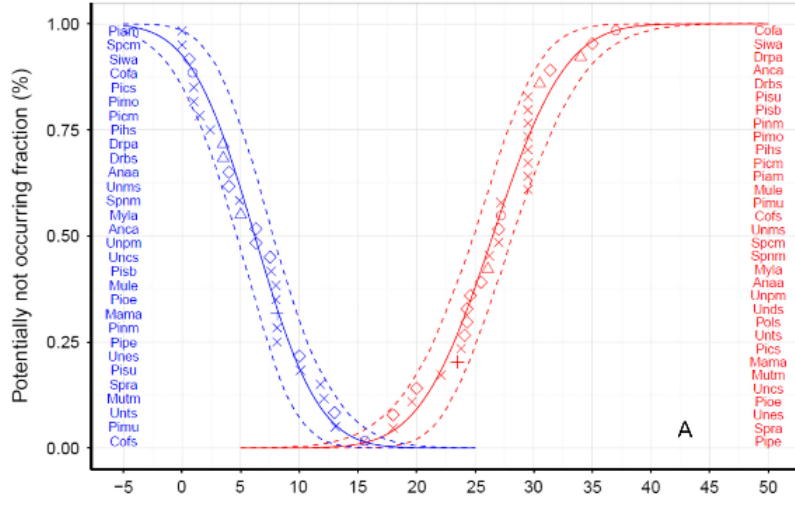

Figure 11: Sensitivity distribution for the minimum habitat temperature (blue line) and maximum habitat temperature (red line) of freshwater bivalve species and the 2.5% and 97.5% confidence intervals (dashed lines). X-axis is the temperature [°C] of the ecosystem. The symbols represent species of the Corbiculidae (circles), Dreissenidae (triangles), Sphaeriidae (crosses), Unionidae (diamonds), and Margaritiferidae (plus signs) (Collas et al., 2018).

With equation 22, 23 and the daily average temperature of the stream (T_E in °C) we can read the PNOF from figure 11. μ_{min} and μ_{max} are the means [°C] for respectively the minimal temperature and maximum temperature requirement in the SSD. σ_{min} and σ_{max} are the standard deviations for respectively the minimum and maximum temperature requirement curve of the SSD. To determine the eventual PNOF per day we selected the highest outcome of both equations. In these formulas T_E is substituted with the stream temperature before (T_{EB}) and after HTE (T_{EA}).

$$PNOF_{min}(t) = 1/2 * \left(1 + erf \left(\frac{T_E - \mu_{min}}{\sigma_{min} * \sqrt{2}} \right) \right) \quad (22)$$

$$PNOF_{max}(t) = 1/2 * \left(1 + erf \left(\frac{T_E - \mu_{max}}{\sigma_{max} * \sqrt{2}} \right) \right) \quad (23)$$

The absolute daily effect ($\Delta PNOF(t)$ in %) of HTE was determined by subtracting the PNOF before HTE from the PNOF after HTE (eq. 24). The relative effect on daily basis was determined by dividing the absolute effect by the PNOF before HTE (eq. 25).

$$\Delta PNOF(t) = PNOF_A - PNOF_B \quad (24)$$

$$\Delta rPNOF(t) = \Delta PNOF / PNOF_B \quad (25)$$

To determine the annual effect we made a summation of the daily PNOF values over the monitored year for both the situation before ($PNOF_B$) and after HTE ($PNOF_A$). Thereafter, we divide it by the amount of analysed days (N_t) to get an (annual) average PNOF ($AAPNOF$) (eq. 26). To determine the absolute effect of HTE on the annual average PNOF of bivalve molluscs ($\Delta AAPNOF$) we subtracted the annual average PNOF after HTE from the annual average PNOF before HTE (eq. 27). To determine the relative effect $\Delta rAAPNOF$ we divided the absolute effect by the PNOF before HTE (eq. 28).

$$AAPNOF = \frac{\sum_{t=1}^{t=N_t} PNOF(t)}{N} \quad (26)$$

$$\Delta AAPNOF = AAPNOF_A - AAPNOF_B \quad (27)$$

$$\Delta rAAPNOF = \Delta AAPNOF / AAPNOF_B \quad (28)$$

In the communicative model in appendix G, ecological analysis - Potentially not Occurring Fraction of Bivlaves, we visualised the steps taken in the model to determine the PNOF.

2.7 Case definition and application

A case was selected and applied to validate the model and to come to quantified ecological effects which can be related to an amount of energy that becomes available for the built environment. For this case the built environment should be close to a stream to make it likely that it is economically feasible to build an HTE installation at this position. Preferably this case should be located in the region managed by water authority Aa and Maas. Moreover, for the stream ecosystem, quantifying data should be available regarding water temperature, water flow, wind speed and geometry. For the HTE-system we required quantifying data regarding the flow, temperature reduction, efficiency of the heat pump and the ATES and the temperature of the built environment and the ATES.

Based on these requirements a stream called the *Goorloop* at the height of the city of Helmond, the Netherlands was selected. The *Goorloop* flows through the built environment of the city of Helmond as can be seen on the map in figure 12. Quantifying data of the stream was available for the time frame of the 22nd of November 2018 until the 22nd of November 2019. Which was guided by the available stream temperature data. It was decided to design a hypothetical HTE-system as no concrete HTE project was available at this location. In the following paragraphs the quantifying data that was used for the case will be explained in more detail and will be divided over the properties of the stream and its environment and the properties of the HTE-system.

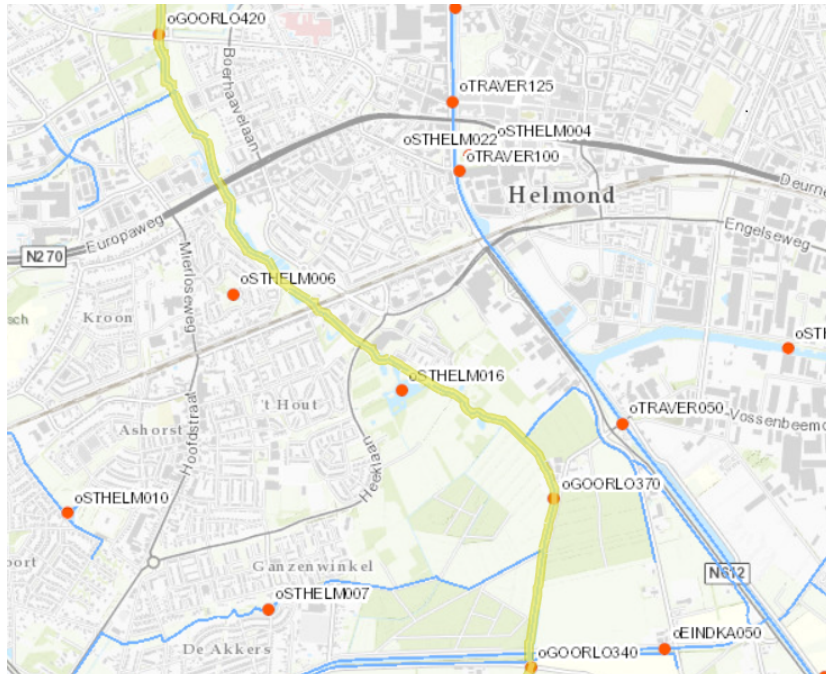

Figure 12: Map showing the part of the Goorloop (yellow line) that flows through the city of Helmond in the Netherlands. oGOORLO420 is the position where the temperature is measured that was used for the analysis. At oGOORLO340 the flow was determined.

2.7.1 Quantifying data: Stream ecosystem

The quantifying data for the case specific stream ecosystem is divided over water temperature, hydraulic data and air data. This is historical data obtained from several data sources which will be explained in more detail below. All the input elements that were supplied with a quantity with the historical stream ecosystem quantifying data are summarized in table 5. Appendix F depicts the course of the stream temperatures, flow and wind speed over the period of interest.

Table 5: Historical quantifying data obtained from ¹water authority Aa and Maas and ²KNMI (n.d.) used in model with symbols and units as used in the model.

Symbol	Input element	Quantity	Unit
$T_{EB}(t)$	Temperature Ecosystem before HTE ¹	Daily average	°C
w_E	Width of the ecosystem ¹	4.25	m
d_E	Depth of the ecosystem ¹	0.5	m
f_{ca}	Cross-section surface fraction ecosystem ¹	0.9	-
$Q_E(t)$	Flow of ecosystem water ¹	Daily average	m^3/s
$U_{10}(t)$	Wind speed ² ('TG' in dataframe)	Daily average	m/s
-	WFD Water type ¹	R5	-

Stream ecosystem temperature was obtained from a sensor implemented in the *Goorloop* since the 22nd of November 2018, called *oGOORLO420* and located at coordinates: 51°28'54.6"N 5°37'57.0"E. This sensor (fig. 14) was selected out of three comparable measuring systems because it measures the water temperature directly downstream of the city of *Helmond* and just before the water enters an ecological interesting area. Since this position still lies against the built environment it remains economically interesting to extract and use the thermal energy from the water. Moreover, at this point it is interesting to determine the potential effects HTE could have on the ecology downstream. Two other temperature measuring points (*oGOORLO360* and *oGOORLO540*) have been considered but assumed to be less interesting because of the larger distance they have from the built environment. Temperature fluctuations in a day have not been taken into account as the primary objective of this model aims at seasonal effects⁹.



Figure 13: The position of the measuring system in the Goorloop that measures among others water temperature.

Hydraulic data includes the flow (Q_E), the width (w_E) and the depth (d_E) of the stream ecosystem at hand. The flow is obtained from the historical database from water authority Aa and Maas and is accessed via Sobek software. The location of the flow measurement is the water pump station *Mierlo*, upstream located at the coordinates 51°27'23.1"N 5°39'23.3"E (fig. 12). There was no flow data available closer to the temperature measurement point. The side streams that connect to the *Goorloop* between the flow measurement point and the temperature measurement point were excluded from the hydraulic data.

In general average day values were available from the 21st of May 2015 until the 3th of November 2019. This means that flow data would be missing from the 4th until the 22nd of November 2019 when referring to the time frame of the temperature measurements. Moreover, there were some occasional missing

⁹Hourly water temperature data was available however

values in the array. All missing data was filled in by using the previous, in time, available value, also called forward fill.

The width and depth of the Goorloop were determined with the help of the cross-section data, as depicted in figure 14, obtained from the GIS system of water authority Aa and Maas. The cross-section that was used is positioned at place of the temperature measurement.

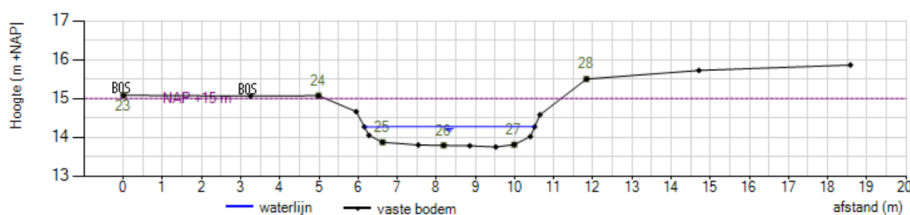

Figure 14: A cross-section of the Goorloop (234001P1390) at place of measuring point oGOORLO420 determined on the 22nd of March 2012 showing that the width (w_E) is approximately 4.25 m, the depth (d_E) is approximately 0.5 m and the cross-section surface fraction (f_{ca}) about 0.9 [–].

Air data includes the wind speed (U10) at the stream which is used for calculating the longitudinal range of the thermal influence in equation 7, 8 and 9. This data comes from an official KNMI measuring station located in Eindhoven, the Netherlands. Which is located approximately 18.5 kilometers from the location of the defined case. Further properties of the weather station are depicted in appendix E.

The water type that is accounted to the Goorloop is R5. Which is defined as a slow flowing stream on sand (STOWA, 2018d).

Fish species preferred and present in the Goorloop are determined in collaboration with an aquatic ecologist from water authority Aa and Maas (personal communication, B. Spierings, May 11, 2020). The fish species of which it was expected and/or preferred to be present in the Goorloop are listed in table 8.

2.7.2 Quantifying data: HTE-system with ATES

Next to the stream ecosystem properties we also needed the thermal and hydraulic data related to the HTE-system. All the input elements that were supplied with a quantity with this data are summarized in table 6.

The temperature change ΔT_{HTE} and the water flow through the HTE-system Q_{HTE} are the most important parameter with which the energy extraction can be controlled. ΔT_{HTE} was based on the values that are currently used in practice (STOWA, 2017a). The water flow can be changed considerably, therefore two configurations have been defined (fig. 15).

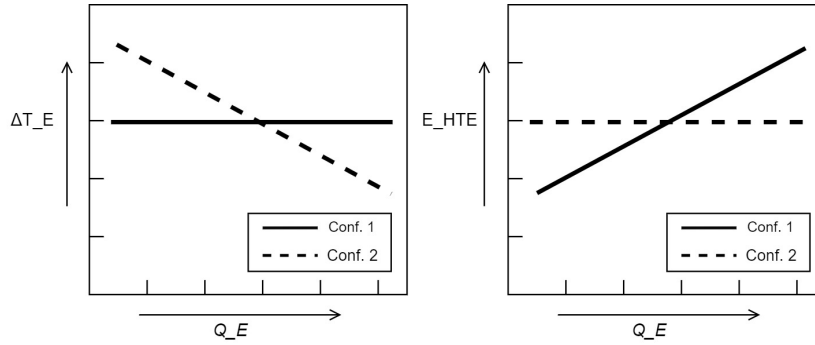

Figure 15: HTE-system flow configurations. Constant stream temperature decrease (configuration one) versus constant thermal energy extraction (configuration two). ΔT_E is the stream temperature decrease after HTE. E_{HTE} is the extracted energy by HTE. Q_E is the water flow through the stream.

With configuration one the temperature decrease of the stream is kept constant by guiding half of the water flow of the stream through the HTE-system. This means that when the flow through the stream increases, the flow through the HTE-system increases as well. As a result the thermal energy extracted from the stream will increase with a increased flow and vice versa. This way the thermal influence on the stream is under control however, this asks for a flexible HTE-system. From efficiency point of view it is preferred that a technical system operates with a static load. Therefore, configuration two has a fixed flow of $0.0877 \text{ m}^3/\text{s}$ based on the average flow through the stream in the analysed period. This configuration will have a constant energy extraction and thus energy delivery. The temperature decrease in the stream will now decrease with an increase in the water flow through the stream and vice versa. $\eta_{ATES}(t)$, T_{ATES} and η_{COP} were based on expert judgement (personal communication, S. Boesten, January 15, 2020). T_{BUILD} was based on the research of CE Delft and Deltares (2018).

Table 6: HTE-system quantifying data used in model

Symbol	Input element	Quantity		Unit
		Config. 1	Config. 2	
ΔT_{HTE}	Temp. change		-5	$^{\circ}\text{C}$
$Q_{HTE}(t)$	Flow of HTE water	$0.5 \cdot Q_E$	0.0877	m^3/s
$\eta_{ATES}(t)$	Efficiency ATES		80	%
T_{ATES}	Temp. ATES		16	$^{\circ}\text{C}$
T_{BUILD}	Temp. built environment		70	$^{\circ}\text{C}$
η_{COP}	Actual - theoretical COP ratio		0.6	[-]

2.8 Programmed model

The programmed model was written in Python code and built with the communicative model (appendix G) as the blueprint. It consists out of six so called model-blocks, the main-block and finally produces output data. In figure 16 the structure of the programmed model is depicted. Every analysis item described in chapter 2.4 and 2.6 is programmed in a separate model-block. The Main-block recalls the code of all model-blocks and finally processes all the codes and data towards the output of the model. The code of every model-block was built with a basic structure:

- Constants definition
- Read and clean data
- Compute all dates
- Plot graphs
- Export data

Under the constants definition we programmed all input elements including the quantifying data that has a single value (e.g. density and specific heat capacity of water, ATES temperature and efficiency). Under 'read and clean data' input elements that are based on a dataframe are read from a .csv file and are made usable for the model (cleaning). Examples of such data frames are the temperature of the stream as function of time and the spawning temperatures and moments of the freshwater fish species. The code for the actual calculations is programmed under 'compute all dates'. To visualize the outcome of these calculations several 'plot graph' functions are programmed after that. Finally the outcome of the calculations is exported to csv-files.

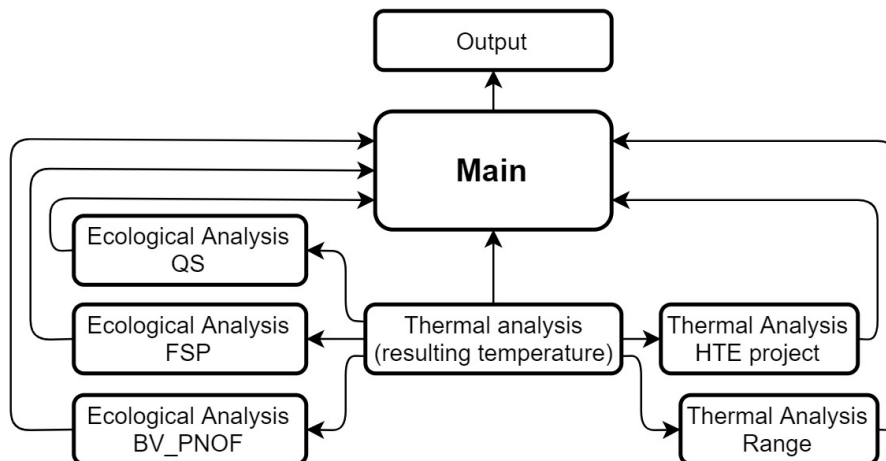

Figure 16: Structure of the programmed model. In the 'main-block' the code from the 'analysis-blocks' is recalled and processed to the output data.

2.9 Verification of the model

With the verification of the model we want to get insight in the validity of the model. We performed this by:

1. checking the method and the results with experts
2. performing random checks for all main model parts
3. checking the sensitivity of the model output

2.9.1 Expert review

The experts that contributed to the validation process are listed in table 7. They have performed a review on both the method and the eventual results of the model.

Table 7: Reviewing experts

Model part	Reviewing expert	Function	Institute
Thermal base	Pascal Boderie	Water Quality and water resources engineer	Deltares
Thermal longitudinal range	Pascal Boderie	Water Quality and water resources engineer	Deltares
HTE-system	Stef Boesten	PhD candidate	Open University
Thermal water quality score	Rick Wortelboer	Senior scientist Water Quality and Ecology	Deltares
Fish spawning potential	Rick Wortelboer	Senior scientist Water Quality and Ecology	Deltares
Potentially not occurring fraction bivalves	Frank Collas	Post doc researcher	Radboud University

2.9.2 Random check

For all main model parts a 'random check' was performed to check whether the calculations, as described in the method, have been programmed correctly in the computer model.

Thermal analysis parts were checked by performing manual calculations. For this we used the data temperature and flow data for the 1th of July. The answers of the manual calculations have been compared to the values in the graphs produced by the model.

Thermal water quality results were checked by comparing the quality score that was given by the model at the 1th of July with the temperature at the same moment and the expected quality score that belongs to this temperature. If the model works correct the quality score should be exactly the same.

Fish spawning potential part of the model was verified on correctness by counting the potential spawning days for the *Misgurnus fossilis* and compared this with the outcome of the model. If the model performs correctly these two values should be exactly the same.

Bivalve PNOF calculations were verified by taking temperature of the ecosystem (T_{EB}) on the 1th of July and performing a manual calculation based on the equations described in this method. Moreover, we derived the PNOF from the SSD graph (fig. 11) at T_{EB} . The values given by the programmed model should be exactly the same as the manual calculation and should approach the values that were read from the graph.

2.9.3 Sensitivity

To determine the sensitivity of the model for variance in the input elements we performed a sensitivity analysis with both configurations of the HTE-system. The subjects below were selected because these are essential for the results of this research and it is expected that these have a considerable influence.

1. temperature influence by HTE
2. thermal recovery from linear to asymptotic in longitudinal range calculation
3. WFD water type

Temperature influence by HTE is the base of this research. Therefore we investigated the sensitivity of all annual results for a difference in temperature change in the HTE-system (ΔT_{HTE}). With this we can determine how sensitive the annual outcome of all six parts of the model is for temperature fluctuations and temperature inaccuracies. We compared the annual outcome of all investigated aspects along a variation of temperature change in the HTE-system (ΔT_{HTE}) of +7, +5, +3, +1, 0 (status quo), -1, -3, -5, -7.

The longitudinal range of the thermal influences was calculated by using the temperature difference between water and air at the start of the recovery process. In real life however, inherently to the thermal recovery process, the water temperature will increase and with this the temperature difference between air and water will decrease. This slows down the temperature recovery process as it will develop asymptotic instead of linear. With this part of the sensitivity analysis we investigate the sensitivity of the outcome of the model for this simplification.

To approach the asymptotic recovery process we calculated the longitudinal range for the thermal situation on the 29th of June 2019 in three linear steps instead of one in the model. For the first step we calculated the longitudinal range from 0% till 33% ($T_{EA} + 0.33 * \Delta T$) of the recovery temperature. For the second step we calculated the longitudinal range from 33% till 66% ($T_{EA} + 0.66 * \Delta T$) of the recovery temperature. For the third step we calculated the longitudinal range for 66% till 100% ($T_{EA} + \Delta T$) of the part of the temperature difference that had to be recovered.

WFD water type is currently defined as R5. However, the difference in thermal water quality with respect to the stream temperature is substantial when the water type group that includes R5 is compared with the group that includes water type R4 and R19. With this part of the sensitivity analysis we determined the sensitivity of the thermal water quality indicator for the water type that was accounted to the stream. The entire analysis was remained the same only the temperatures corresponding to the quality score indication of the R5 water type was replaced with temperatures corresponding to the R4 water type.

3 Results

The result of this research is insight in the effect of the cold water discharge from HTE on the stream ecology. This consists of the size of the thermal influence and the status of and the effect on the ecological indicators. This insight was generated with the dynamic model that was built and in which the Goorloop case, with two HTE-system configurations (explained in fig. 15), was applied. To refresh the readers memory we will shortly describe the selected thermal characteristics and ecological indicators again in each subsection since these form the core of the model.

The results of the analysis regarding the sensitivity of the outcome of the model for variation of the temperature change in the HTE-system is depicted and discussed in appendix I. Included in these results are: the annual extracted thermal energy from the stream, the annual available thermal energy for the built environment, the annual quality score, the annual spawning potential and the annual average bivalve PNOF.

3.1 Size of thermal influence

The selection of the characteristics that describe the thermal influence of HTE on the stream are in explained in chapter 2.3. The *incoming thermal energy* is the amount of energy in the stream until the freezing point of water. The *extracted thermal energy* is the amount of thermal energy the HTE-system extracts from the stream. The *resulting temperature* is the temperature of the stream after thermal energy extraction by the HTE-system. This is the characteristic on which all ecological calculations and the following thermal calculations are based. The *annual available energy for the built environment* is the available thermal energy after several conversions were made in the total thermal energy solution in which the HTE-system is applied. The annual available energy for built environment was assigned as an essential thermal characteristic since this quantifies the primary function of an HTE-system. The *longitudinal range of the thermal influence* is the distance from the point of thermal energy extraction until the point where the thermal balance is recovered to the specifications before HTE. The stream cross-section area that was calculated for the longitudinal range is 1.9 m^2 . The calculations of the last two characteristics are based on the resulting temperature calculations. With the calculations behind these characteristics we are able to tell what the size of the thermal influence of the HTE-system on the thermal balance of the Goorloop will be.

Configuration 1 Figure 17a shows the course of the original temperature of the stream before HTE (T_{EB}) and the resulting temperature after HTE (T_{EA}) with configuration one. With respect to each other we see almost a constant difference of $2.5 \text{ }^\circ\text{C}$ (fig. 17b). This is a direct result of the dependency between the flow through the HTE-system and the flow through the stream ecosystem. Although this is not an advanced calculation and result, it is depicted as a result so that it can be compared with the resulting temperature and temperature difference with the configuration two HTE-system.

The thermal energy that is available for the built environment per day over the period that was analysed, is depicted in figure 17c. The curve has the same profile as the flow through the stream (app. F. This is the result of the programmed dependency between the flow in the stream ecosystem and the flow through the HTE-system. The annual amount of energy that is extracted from the stream is 27.8 TJ and eventually 22 TJ is available for the built environment.

The longitudinal range for configuration one is depicted in figure 17d. The course of λ is depicted in appendix H. On average the longitudinal range is 2.9 km. The longest range is 10 km on the 14th of March. The shortest range is 0.5 km on the 1th of December 2018. The sensitivity of the model for the assumption of a linear thermal recovery instead of the more realistic asymptotic recovery was +124% for the situation on the 1th of July. In appendix I the sensitivity for the temperature change in the HTE-system of the extracted thermal energy, the available energy for the built environment and the longitudinal range is depicted.

Configuration two Figure 18a shows the course of the original temperature of the stream before HTE (T_{EB}) and the resulting temperature after HTE (T_{EA}) with configuration two. In figure 18b the difference between the temperature before and after HTE is depicted. Here we see more variation in the temperature decrease than with configuration one. This is the consequence of the fixed water flow through, and thermal energy extraction by, the HTE-system while the incoming energy in the stream varies. The maximum temperature decrease is 18.1 °C on the 26th of June. The minimum temperature decrease is 1.15 °C on the 16th of March. This is the result of respectively a relatively low and high flow in the stream.

The energy that is available for the built environment per day over the period that was analysed, is depicted in figure 18c. It is relatively constant as the flow through the HTE-system is constant. The annual extracted energy from the stream is 52.6 TJ and for the built environment 41.8 TJ is available. The longitudinal range is depicted in figure 18d. The course of λ is depicted in appendix H. On average the longitudinal range is 2.5 km. The longest range is 9 km on the 14th of March. The shortest range is 0.5 km on the 1th of December 2018. The sensitivity of the model for the assumption of a linear thermal recovery instead of the more realistic asymptotic recovery was +120% for the situation on the 1th of July.

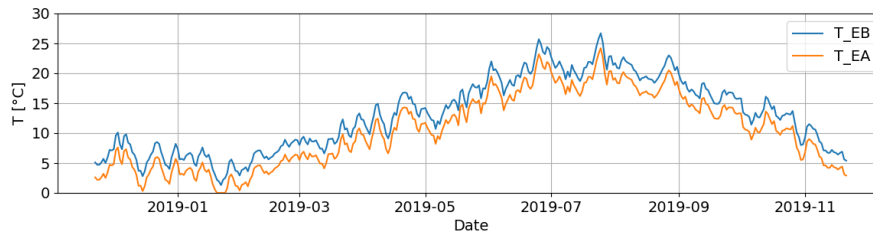

(a) Temperature course before and after HTE was applied.

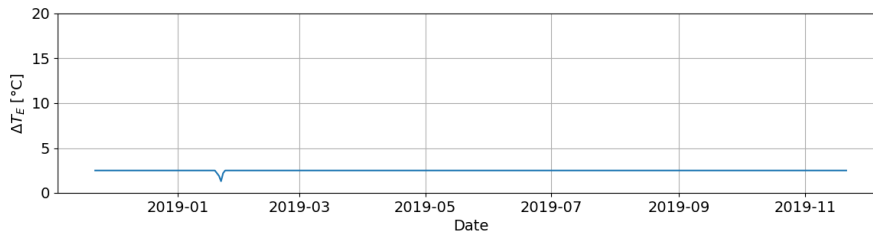

(b) Temperature decrease after HTE was applied. Over the entire time period the temperature of the stream decreased with 2.5 °C.

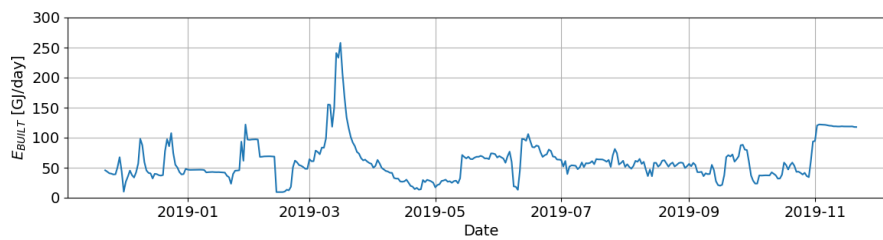

(c) Energy available for the built environment per day. The annual sum is 22 TJ.

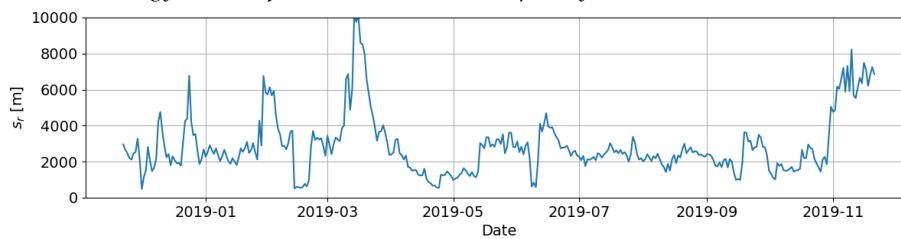

(d) The longitudinal range that the thermal influence of HTE has, per day, in the direction of the water flow. The average range is 2.9 km. The minimum range is 0.5 km. The maximum range is 10 km.

Figure 17: Resulting size of thermal influence with configuration one HTE-system.

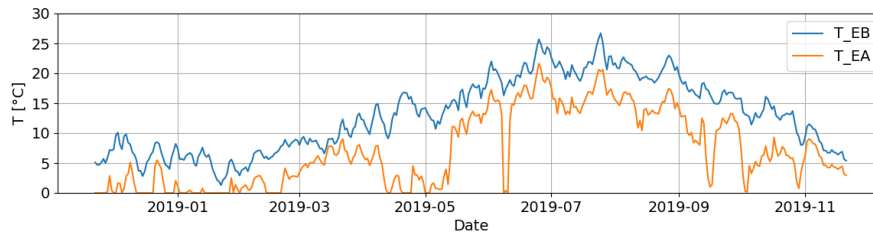

(a) Temperature course before and after HTE was applied.

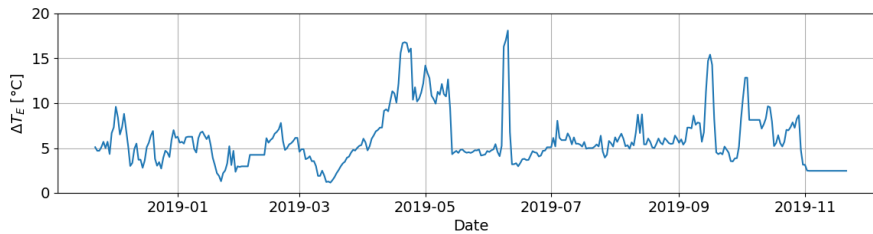

(b) Temperature decrease after HTE was applied. The maximum temperature decrease is 18.1 °C and the minimal temperature decrease is 1.15 °C.

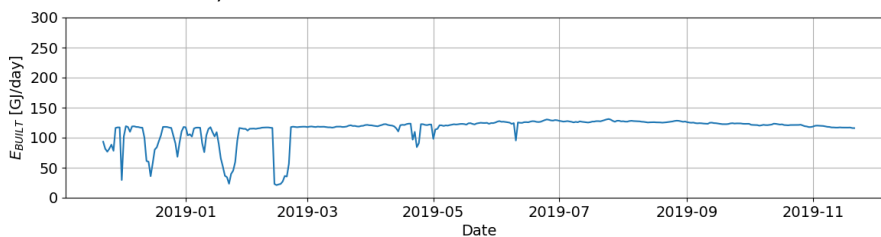

(c) Energy available for the built environment per day. The annual sum is 44 TJ.



(d) The longitudinal range that the thermal influence of HTE has, per day, in the direction of the water flow. The average range is 3 km. The minimum range is 0.5 km and the maximum range is 9.9 km

Figure 18: Resulting size of thermal influence with configuration two HTE-system.

3.2 Ecological indicators: status and effect

In section 2.5 of the method chapter we discussed the selection of the ecological indicators which can be used for quantification of the effect of cold water discharge on the ecology of a stream. We have applied the *general thermal-water quality* that classifies the water quality based on the temperature of a stream. Moreover we applied the *fish spawning potential* with which we determined whether abundant fish species have the ability to spawn based on a temperature and monthly time window. Furthermore, we applied the Bivalve Species Sensitivity Distribution with which we determined the *Potentially not Occurring Fraction of Bivalves*.

In the following subsections we will analyse the ecological indicators separately, for the Goorloop case. For each indicator we will describe the status before and after HTE, per HTE-system configuration, and we will describe the effect of the cold water. Moreover, we will treat the results of several sensitivity analysis. In appendix I the sensitivity for the temperature change in the HTE-system of the thermal water quality, the fish spawning potential and the bivalve PNOF is depicted and discussed.

3.2.1 General thermal water quality score

In this subsection we will describe the results regarding the status of the general thermal water quality before and after HTE as well as the effect of HTE on the general thermal water quality. A distinction is made between configuration one and configuration two of the HTE-system. Moreover, we will discuss the sensitivity of the model for the allocation of an R4 water type to the stream instead of the official R5 water type¹⁰.

In figure 19a and 20a the status of the thermal water quality score before HTE (QS_B) is depicted. The highest annual score that can be reached is 1460 QSP . With the allocation of the original R5 water type we see that the temperature exceeds the 'very good' threshold from the 24th until the 30th of June and from the 23th until the 26th of July. The quality score becomes 'good' or even 'moderate'. The annual thermal water quality score before HTE is 1445 QSP . When the R4 water type is allocated to the stream the quality score starts exceeding the 'very good' threshold on the 18th of April. On the 18th of October the stream temperature is recovered to the 'very good' quality. The annual quality score before HTE is 1123 QSP .

Configuration one In figure 19a the status of the thermal water quality after (QS_A) HTE for both the R5 and the R4 water type is depicted. In the situation after HTE, and the R5 water type allocated to the stream, on the 25th of June and on the 24th and 25th of July the temperature exceeds the 'very good' threshold and gets the classification of 'good' (3 QSP). The annual thermal water quality score after HTE is 1457 QSP . The absolute effect of HTE (dQS_{R5} in fig. 19b) is

¹⁰See table 3. e.g. in case of the R5 water type, a score of 4 QSP will be reached when stream temperature is lower than 23 degrees Celsius. In case of the allocation of the R4 water type, temperature needs to be below 14 degrees Celsius to receive a quality score of 4 QSP .

an increase of the quality score with one *QSP* on ten days at the end of June and at the end of July. The quality score is two *QSP* higher on one day in July. The quality score does not drop below 3 *QSP* (good) any more. In figure 19c the relative trend of the effect is depicted. The annual effect of HTE is an increase of 12 points. When compared to the situation before HTE the score increases with 0.83%.

When the R4 water type is allocated to the stream the thermal water quality score after HTE starts exceeding the 'very good' threshold on the 18th of May and recovers on the 27th of September. The annual quality score after HTE is 1261 *QSP*. In this case the effect of HTE looks like dQS_{R4} as depicted in the graph of figure 19b. The effect of HTE is positive to the quality score from April until, through October. The quality score is raised mainly with 1 *QSP* per day and on some days with 2 *QSP*. With this the annual effect of HTE on the thermal water quality is an increase of 138 *QSP* which is +9.55% when compared to the quality score before HTE.

Configuration 2 In figure 20a the status of the thermal water quality after HTE (QS_A) for both the R5 and the R4 water type is depicted. In case the original R5 water type is allocated to the stream the annual thermal water quality score becomes as high as possible; 1460 *QSP*. All the moments at which the quality score before HTE were lower than 'very good' are brought to the maximum score. The effect per day is depicted in figure 20b, dQS_{R5} . On annual basis this means an increase of 15 *QSP*. The relative effect is depicted in figure 20c, dQS_{R5} . Annually the relative effect becomes +1%.

If an R4 water type would have been assigned to the Goorloop the thermal water quality score would have looked like QS_{R4} . It starts exceeding 23 °C -the 'very good' water quality threshold- on the 1th of June and finally recovers on the 1th of September. The annual score would have been 1372 points. The effect of HTE would have looked like as curve dQS_{R4} depicted in figure 20b. In this case we also see a positive effect on the thermal water quality score from April until, through October. The quality scores mainly raises with one and two points on a day and in several cases with three points. The annual thermal water quality score increases with 249 *QSP*. In figure 20c $drQS_{R4}$ describes the relative effect of HTE in this case. The annual effect of HTE on the quality score is +17.05% . Moreover, the quality score does not drop below 1 *QSP* (insufficient) any more.

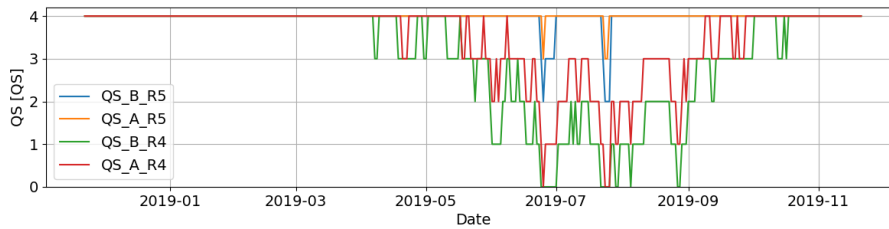

(a) The status of the thermal water quality score before (QS_B) and after (QS_A) HTE for both the R5 and the R4 water type. The annual sum for QS_B_{R5} is 1445, for QS_A_{R5} this is 1457, for QS_B_{R4} it is 1123 and for QS_A_{R4} it is 1261.

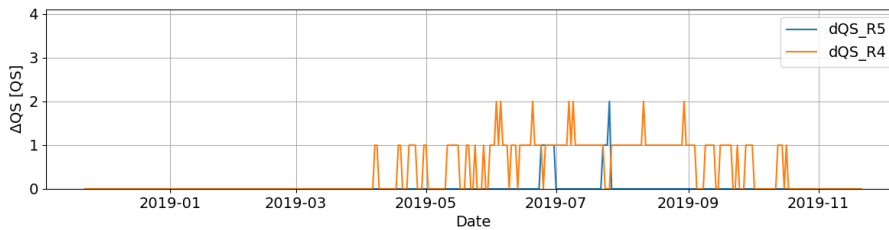

(b) The effect of HTE on the thermal water quality score. Annually the effect is +12 points with the R5 water type dQS_{R5} and +138 points with the R4 water type dQS_{R4} .

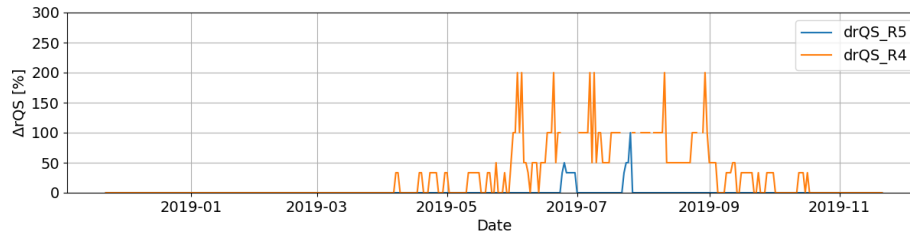

(c) The relative effect of HTE with respect to the status before HTE for both the R5 ($drQS_{R5}$) and R4 ($drQS_{R4}$) water type. The annual average increases respectively with 0.83% and 9.55%. Missing data points are caused by a score of 0 QSP in the situation before HTE since this results in an infinite increase of the relative quality score.

Figure 19: The status of, and the effect on, the general thermal water quality score with configuration 1 of the HTE-system.

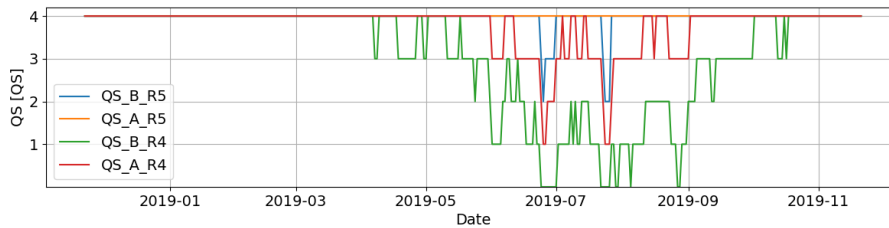

(a) The annual sums for QS_B_R5 is 1445, for QS_A_R5 this is 1460, for QS_B_R4 it is 1123 and for QS_A_R4 it is 1372.

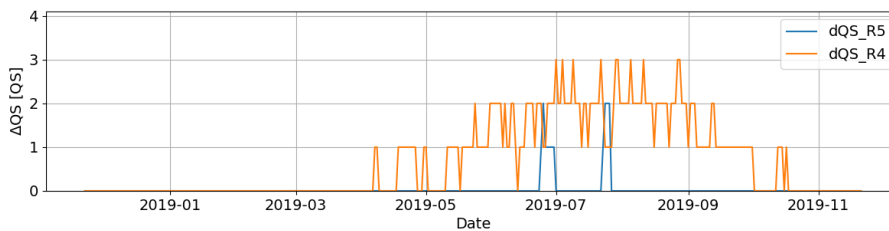

(b) The effect of HTE on the thermal water quality score. Annually the effect is +15 points with the R5 water type (dQS_{R5}) and +249 points with the R4 water type (dQS_{R4}).

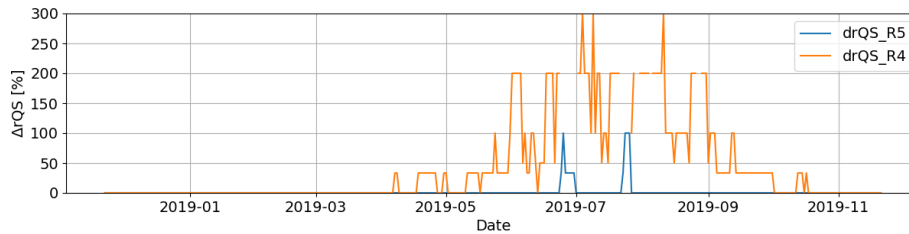

(c) The relative effect of HTE with respect to the status before HTE for both the R5 ($drQS_{R5}$) and R4 ($drQS_{R4}$) water type. The annual average increases respectively with 1% and 17.05%. Missing data points are caused by a score of 0 QSP in the situation before HTE since this results in an infinite increase of the relative quality score.

Figure 20: The status of, and the effect on, the general thermal water quality score with configuration 2 of the HTE-system.

3.2.2 Fish spawning potential

The status of the fish spawning potential before HTE (SP_B) is depicted in figure 21a. The first fish species are able to spawn on the 1th of February. We see a steady incline towards summer and a steady decline towards autumn. After August no fish species are able to spawn any more. The largest amount of fish species (nine) are able to spawn on the 31th of May and on the 6th, 11th, 14th and the 16th of June. The annual amount of fish spawning potential days is 882 SPD. In table 8 and 9 the status of the annual amount of spawning days per fish species before HTE (SP_B) is depicted. In this table we also see the fish species that are expected and aimed to be present in the Goorloop. The pike (*Esox lucius*) has the most spawning potential days (143). The gudgeon (*Gobio gobio*) has the least amount of spawning potential days (43).

Configuration one The status of the fish spawning potential after HTE (SP_A) is also depicted in figure 21a. Comparable to the situation before HTE we see a steady incline towards summer and a steady decline towards autumn. The largest amount of fish species that are able to spawn is also nine. This is reached on the 18th and the 22nd of May and on the 6th of August. The annual amount of fish spawning potential days for the situation after HTE is 872. In figure 21b the effect of HTE on the daily fish spawning potential is depicted. It starts to be negative on the 2nd of February. The maximum decrease in spawning potential is three fish species on several moments in May. The total amount of negative fish spawning potential days is 105 in the analysed year. Starting from the 29th of May until the 31th of October the effect of HTE is mainly positive. The largest positive effect is a spawning potential increase of 3 SPD. The annual sum of added potential spawning days is 95 SPD. Thus, in the whole year the amount of fish spawning potential days will decrease with 10 SPD. When we compare the absolute effect to the spawning potential before HTE we get the curve as plotted in figure 21c. With respect to the situation before HTE the maximum increase is 100% on the 27th of July the maximum decrease is 100% on the 20th of August. On annual basis the spawning potential decreases with 1.13%.

The annual status of, and the effect of the configuration one HTE-system on, the spawning potential of individual fish species is depicted in column dSP of table 8. After HTE the pike (*Esox lucius*) is still the species that has the most spawning potential days (149 SPD). The fish species with the least amount of spawning potential days (25 SPD) is now the belica (*Leucaspius delineatus*). The largest decrease in spawning potential is 21 days for the common rudd (*Scardinius erythrophthalmus*). The largest increase in spawning potential is 28 SPD for the threespine stickleback (*Gasterosteus aculeatus*). When comparing the effect of HTE on the spawning potential to the spawning potential before HTE, the spined loach (*Cobitis Taenia*) has the largest decrease of 35%. The common nase (*Chondrostoma nasus*) has the largest increase of 44.4%.

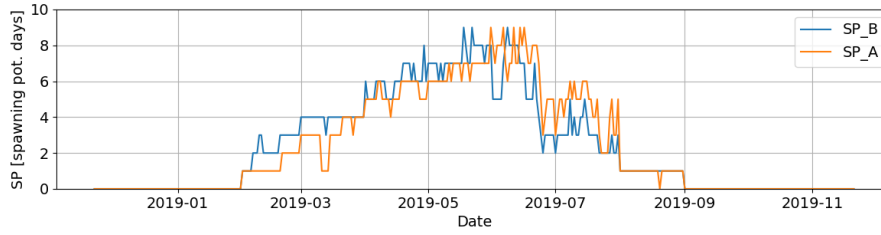

(a) The status of the spawning potential before (SP_B) and after (SP_A) HTE. The annual spawning potential is 882 before HTE and 872 after HTE.

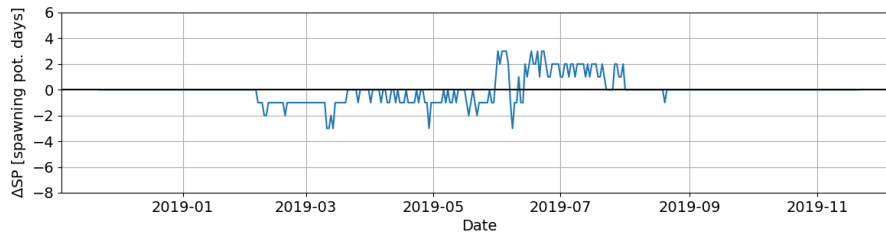

(b) The effect of HTE on spawning potential days. Annual effect is -10 days.

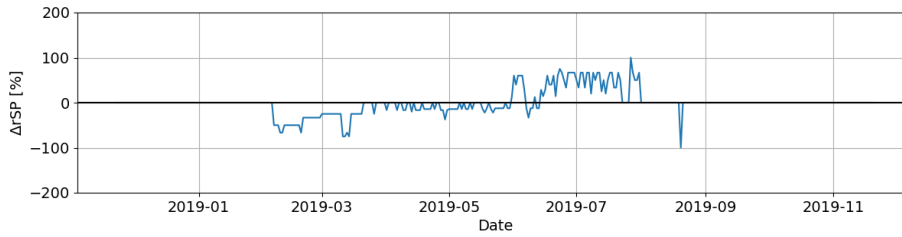

(c) The relative effect of HTE on the spawning potential days. Annual effect is -1.13%

Figure 21: The status of, and the effect on, the fish spawning potential with configuration 1 of the HTE-system.

Table 8: Annual spawning potential before (SP_B) [SPD] and after (SP_A) [SPD] the **configuration one** HTE-system, absolute (dSP) [SPD] and relative effect (drSP) [%] per fish species.

Scientific fish species name	SP_B	SP_A	dSP	drSP
Barbatula barbatula	46	36	-10	-21.7
Cottus gobio	70	57	-13	-18.6
Esox lucius	143	149	6	4.2
Gasteroceus aculeatus	79	107	28	35.4
Gobio gobio	43	44	1	2.3
Leucaspis delineatus	45	25	-20	-44.4
Leuciscus leuciscus	82	83	1	1.2
Perca fluviatilis	101	125	24	23.8
Rutilus rutilus	75	86	11	14.7
Scardinius erythrophthalmus	95	74	-21	-22.1
Tinca tinca	103	86	-17	-16.5

Configuration two The status of the fish spawning potential in combination with the configuration two HTE-system is depicted in figure 22a. The first fish species are able to spawn on the 1th of February. Until the beginning of March this remains one species. Through March and the beginning of April the spawning potential fluctuates between 4 and 1 *SPD*. Through April and the first half of May the spawning potential drops to 1 *SPD* again. At the half of May we see a sharp increase of the spawning potential. Until the end of July this remains between 5 and 9 *SPD* with one dip at the beginning of July. On the 1th, 14th, 15th and the 20th of June the most species (9) are potentially able to spawn. At the end of July the spawning potential drops quite abrupt to 0 *SPD* for the rest of the year with the exception of eight days on which one species is potentially able to spawn. The annual spawning potential is 668 *SPD*.

In figure 22b the effect of HTE on the daily fish spawning potential is depicted. It starts to be negative on the 6nd of February. The maximum decrease in spawning potential is 8 *SPD* on the 8th of June. The total amount of negative fish spawning potential days is 341 *SPD* in the analysed year. Starting from the 14th of June until the 31th of July the effect of HTE is mainly positive. The highest positive effect is an increase of 5 *SPD*. The annual sum of added potential spawning days is 126 *SPD*. Thus, in the whole year the amount of fish spawning potential days will decrease with 215 *SPD*. When we compare the absolute effect to the spawning potential before HTE we get the curve as plotted in figure 22c. With respect to the situation before HTE the maximum increase is 167% on the 27th, 28th and 30th of June. The maximum relative decrease is 100% on the 19th of February and on nineteen moments in August. On annual basis the spawning potential decreases with 24.38%.

In table 9 the results for the status of, and the effect on, the annual spawning potential per fish species are depicted. Also after the configuration two HTE-system the pike (*Esox lucius*) remains the species with the largest spawning potential of 150 *SPD*. The fish species with the least amount of spawning potential is now the belica (*Leucaspilus delineatus*) with 16 *SPD*. The tench (*Tinca tinca*) has the largest reduction of spawning potential days (64 *SPD*). Six of the eleven fish species see a reduction of more than 20 *SPD*. However, some fish species see a minor increase. The pike has the largest increase of 7 *SPD*. When the absolute effect is compared to the status before HTE than we see the biggest reduction of 64.4% for the belica (*Leucaspilus delineatus*). The relative spawning potential increase is the largest (11.6%) for the gudgeon (*Gobio gobio*).

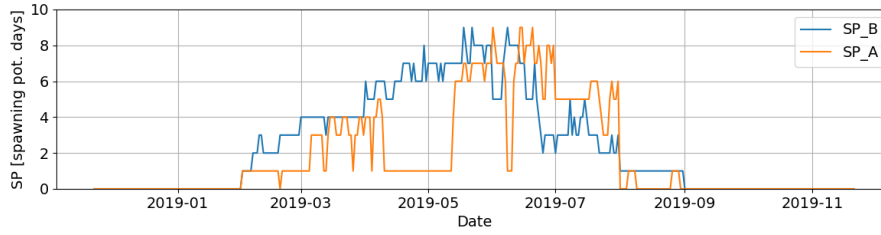

(a) The status of the spawning potential before (SP_B) and after (SP_A) HTE. The annual spawning potential is 882 days before HTE and 667 after HTE.

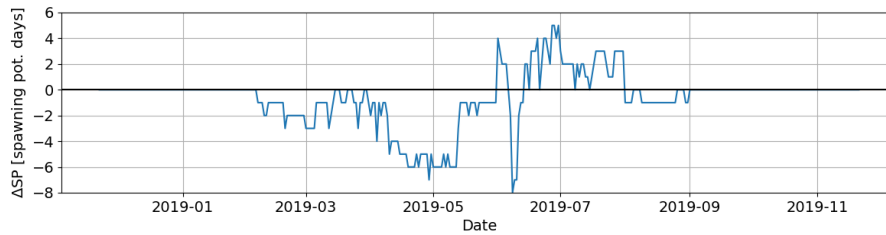

(b) The effect of HTE on spawning potential days. Annual effect is -215 days.

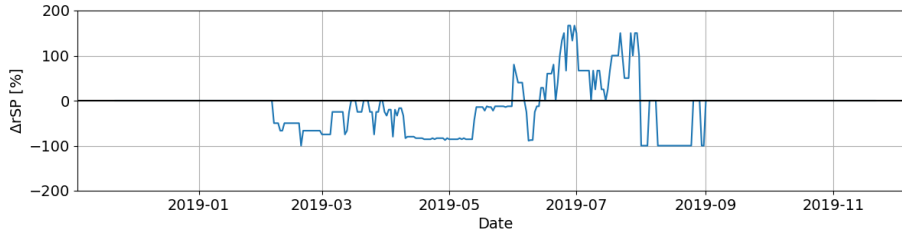

(c) The relative effect of HTE on the spawning potential days. Annual effect is -24.38%

Figure 22: The status of, and the effect on, the fish spawning potential with configuration 1 of the HTE-system.

Table 9: Annual spawning potential before (SP_B) [SPD] and after (SP_A) [SPD] the **configuration two** HTE-system, absolute (dSP) [SPD] and relative effect (drSP) [%] per fish species.

Scientific fish species name	SP_B	SP_A	dSP	drSP
Barbatula barbatula	46	23	-23	-50.0
Cottus gobio	70	36	-34	-48.6
Esox lucius	143	150	7	4.9
Gasteroceus aculeatus	79	80	1	1.3
Gobio gobio	43	48	5	11.6
Leucaspilus delineatus	45	16	-29	-64.4
Leuciscus leuciscus	82	50	-32	-39.0
Perca fluviatilis	101	100	-1	-1.0
Rutilus rutilus	75	76	1	1.3
Scardinius erythrophthalmus	95	50	-45	-47.4
Tinca tinca	103	39	-64	-62.1

3.2.3 Potentially not Occurring Fraction of Bivalves

The status of the bivalve PNOF before the implementation of HTE is depicted in figure 23a and 24a. In the situation before HTE the PNOF (PNOF_B) is relatively high at the end of autumn and in the first half of winter. With the highest PNOF of 0.87 on the 22nd of January. It decreases when water temperature rises at the end of winter and during spring. In April and May the temperature of the stream is around 15 °C which results in a PNOF that approaches 0 on multiple days. In summer temperatures rise above 15 °C which results in a higher PNOF. The highest PNOF value in summer is 0.52 on the 25th of July. In September the temperature of the stream has decreased to 15 °C again resulting in a PNOF around 0. Starting from the end of October the water cools down further and as a result of the minimum temperature requirement of the SSD the PNOF rises. The average PNOF on annual basis, for the situation before HTE is 0.24.

Configuration one The status of, and the effect on, the bivalve PNOF after application of HTE with **configuration one** is depicted in figure 23. In figure 23a we see that the character of the PNOF curve (PNOF_A) is comparable to the situation before HTE. However, the highest PNOF is now 0.96 on the 22nd of January. The stream temperature approaches 15 °C, and a PNOF of almost 0, in late May. The stream temperature is higher than 15 °C until September and reaches the highest (summer) PNOF of 0.32 on the 25th of July. The stream temperature drops below 15 °C again at the end of September. The annual average PNOF in the situation after HTE is 0.32.

The absolute effect of the thermal influence of HTE on the bivalve PNOF is depicted in figure 23b. From the start of the analysed period until the end of May the PNOF is, on average, 0.17 points higher than it was before HTE. The largest increase is 0.23 on 37 days. From the end of May until the start of September the PNOF is, on average, 0.07 lower. The largest decrease is 0.20 on the 25th of July. In September the effect of HTE results in a higher PNOF again. The largest increase is 0.23 on 11 days. On average the bivalve PNOF increases with 0.08 as a result of HTE. In figure 23c the relative effect (the absolute effect with respect to the PNOF before HTE) is depicted. From the start until half of June the PNOF increases between 6% and 280%. After relatively large fluctuations the relative effect stabilizes between -40% and -70% until the start of September. Again several large fluctuations can be seen until the end of September. From then on the relative effect remains positive again with values between 35% and 280%. The annual average bivalve PNOF increases with 35 %.

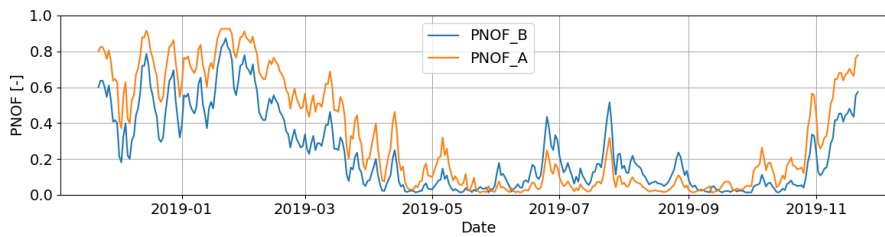

(a) The PNOF of freshwater bivalves before and after HTE application. The annual average PNOF is 0.24 before HTE and 0.32 after HTE.

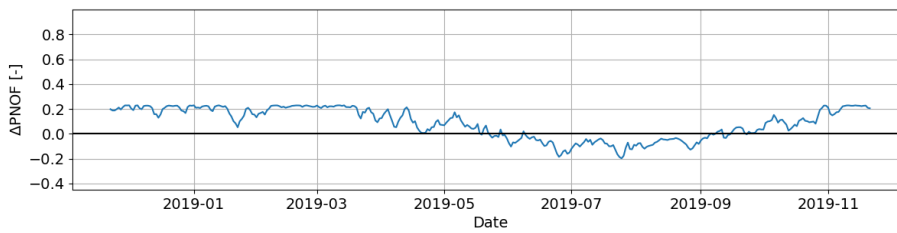

(b) The difference between the PNOF of freshwater bivalves before and after HTE application plotted along the times axis. The effect of HTE on the average PNOF is +0.08.

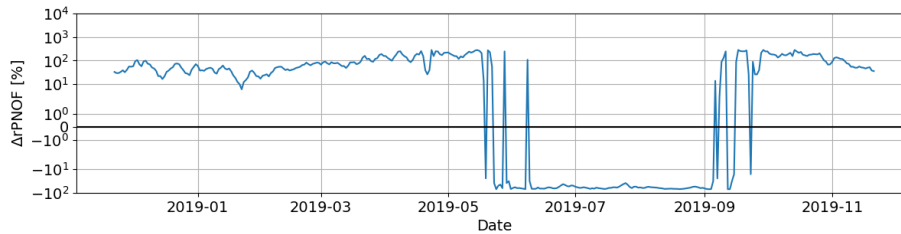

(c) The relative effect of HTE on the bivalve PNOF. The effect on the annual average is +35.43%

Figure 23: The status of, and the effect on, the bivalve PNOF with *configuration one* of the HTE-system.

Configuration two The status of the bivalve PNOF after application of HTE with **configuration two** is depicted in figure 24a. The PNOF curve has a more extreme character. From half of November until the end of February and in April and the beginning of May the PNOF is often at values around 0.95. After a rapid decline the PNOF stays below 0.2 from the second half of May until September with an exceptional 0.95 peak at the beginning of July. With values varying between 0.2 and 0.9 the PNOF curve inclines again at the start of September and approaches 0.8 at the end of November. The annual average PNOF in the situation after HTE is 0.49.

The absolute effect of the thermal influence of HTE on the bivalve PNOF is depicted in figure 24b. From the start of the analysed period until the end of May the PNOF is, on average, 0.41 higher than it was before HTE. Several peaks can be seen, at the end of April and the beginning of May, that are larger than 0.8. The largest increase is 0.91 on the 23th and the 24th of April and on the 8th of June. From the end of May until the start of September the PNOF is, on average, 0.08 lower than it was before HTE. The largest decrease is 0.41 on the 25th of July. From the start of September the effect of HTE results in a higher PNOF again. The largest increase is 0.87 on the 16th of September. On average the bivalve PNOF increases with 0.26 as a result of HTE.

In figure 24c the relative effect (the absolute effect with respect to the PNOF before HTE) is depicted. From the start until half of June the PNOF increases between 6% and 5498%. After relatively large fluctuations the relative effect stabilizes between -4% and -92% until the start of September. From then on the relative effect remains positive again with values between 14% and 6348%. The annual average bivalve PNOF increases with 108.34 %.

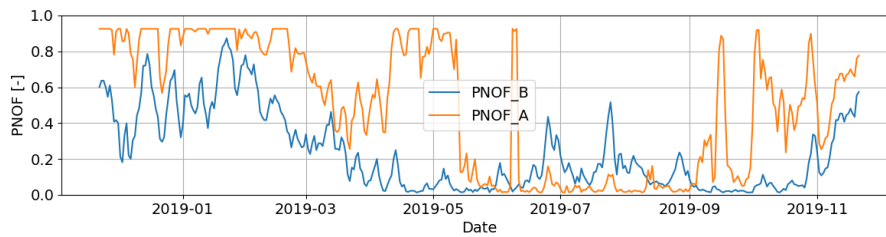

(a) The PNOF of freshwater bivalves before and after HTE application. The annual average PNOF is 0.24 before HTE and 0.49 after HTE.

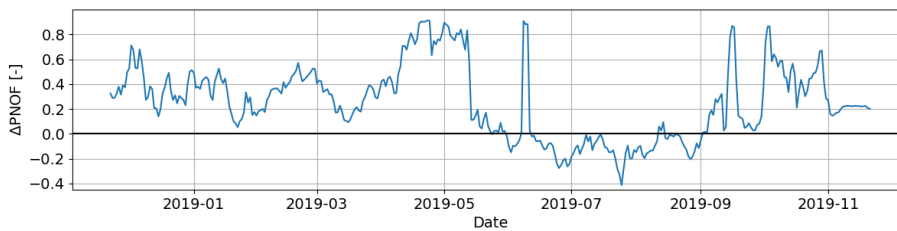

(b) The difference between the PNOF of freshwater bivalves before and after HTE application plotted along the times axis. The effect of HTE on the annual average PNOF is +0.26.

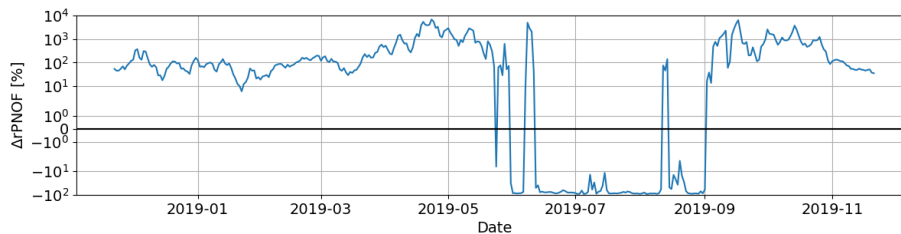

(c) The relative effect of HTE on the bivalve PNOF. The effect on the annual average is +108.34%

Figure 24: The status of, and the effect on, the bivalve PNOF with **configuration two** of the HTE-system.

4 Discussion and conclusion

In this section we will discuss the strengths and weaknesses of the model and the results of this study. Moreover we will appoint opportunities for further research and development of the model. Thereafter, we will draw the conclusions based on the applied method and the results produced by the model.

4.1 Discussion

The discussion of this research is built as depicted in figure 25. The model is the base for this research and contains several unique aspects but also assumptions and limitations. The same is valid for the implemented case of the Goorloop. Running the model with the Goorloop case has produced the results that of course still contain the unique elements and limitations of the previous steps but also has some topics for discussion of its own. Finally, with all the pro's and con's of the model, applied case and the results we discuss the value of the conclusions we can draw from this research.

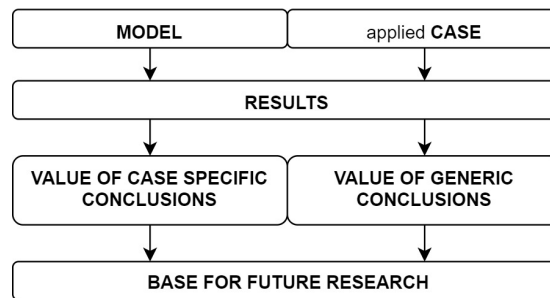

Figure 25: Relation between aspects of the discussion

4.1.1 Model

Modelling the influence of thermal energy recovery with HTE on the selected ecological indicators in a stream, makes this study unique. The selected ecological indicators cover multiple trophic levels of the stream ecology. As mentioned before ecosystems are complex interactions between organisms and their biophysical environment. Influencing one or more ecological indicators on one or more trophic levels can, via a web of interactions, result in effects on the entire ecology. Therefore, this model can be used to get a first insight in the potential effect thermal energy recovery by HTE can have on the ecology of a stream. Besides, although the size of the effects of HTE on the different ecological indicators is not directly aggregatable, the course of the effects over time can provide an indication of the direction (positive or negative) of the effect. The model has some limitations however, which will be discussed below.

Firstly, the selected set of indicators do not cover all aspects of the stream ecology. To determine the potential effect of thermal energy recovery more accurately it is recommend to implement more ecological indicators. Macrophytes

for example remain an interesting ecological indicator to include because of their crucial role in a freshwater ecosystem (STOWA, 2017a). Besides, the used bivalve SSD was based on European species and not all species are present in the Netherlands and the specific stream (personal communication F. Collas, March 5, 2020). This could lead to overestimation of the PNOF especially in winter (personal communication F. Collas, July 29, 2020). Selecting the present bivalve species, comparable to the approach with the fish species, would give more representative results.

Limiting blue algae (Cyanobacteria) blooms is one specific ecological aspect mentioned in many media (STOWA, 2018c) on which cold water discharge from HTE could have a positive influence. This cannot directly be proved with this model. However, an aquatic system with a good ecological quality has a smaller chance for blue algae blooms than an aquatic system with a bad ecological quality. With this one could say that positive effects on the ecology could, but not necessarily, have a positive effect in reducing the chance for a blue algae bloom. As this model does provide some insight in the potential positive effect of HTE on the ecology it may help with designing a solution for the blue algae problems.

Secondly, except for the fish spawning temperature no temperature trigger values¹¹ have been taken into account. For bivalves these could provide insight in the effect HTE could have on competition between endemic and exotic lobster species (personal communication F. Collas, March 5, 2020). Temperature trigger values also addresses the concern of many aquatic ecologists regarding fish stopping their migration to their spawning ground as a result of thermal plumes that form a cold water barrier (STOWA, 2018c). In this study a homogeneously divided temperature over the entire cross-section of the stream was assumed. Although this is likely for (very) small streams it was not validated and therefore it is a point of attention since the effect on the ecology also may differ from the position in the cross-section of the stream.

Thirdly, present stressors such as chemical pollution and draught can play a role. To predict the actual effect of HTE on the ecology of a stream it is recommended to take these into account¹².

Fourthly, the longitudinal range of the thermal influence reported in the results provides a first idea of the order of magnitude of the size of the thermal influence. However, the sensitivity analysis shows that this is a significant under estimation because of the linear simplification. Moreover, the change of the size of the thermal influence, and with this the effect on the ecology, during the recovery of the thermal balance was not taken into account.

Fifthly, the model includes only one HTE-system setup. Other system setups are thinkable however. For example a system without thermal energy storage and an HTE-system that combines warm¹³ and cold water discharge.

¹¹Temperatures that trigger organisms to become active, start feeding, grow and reproduce.

¹²Important to mention is that the actual influence of an HTE-system on the ecology is dependent on more influencing mechanisms than only the thermal influence. Also chemical (ecotoxicological from anti fouling strategies), mechanical (damaging or killing organisms in the pump installations) and hydrological (induced flow in the stream as a result of the pump installation) influences can play a role.

¹³Which is a realistic configuration when cooling the built environment in the summer is also

4.1.2 Case

The applied case of the Goorloop meets the requirements of the used definition of a small, slow flowing freshwater ecosystem. The available daily temperature and flow data enabled a detailed analyses. Moreover, the geographic position of the case is representative since the built environment is close by which makes recovery of thermal energy a realistic alternative solution for heating the buildings of this region. The case has some shortcomings however.

Firstly, the representativeness of the single stream and the time frame of one (historically warm) year can, from statistical point of view, be discussed. The dimensions of the cross-section, the temperature and the flow can vary considerably compared to other streams. To be able to produce more representative results, to base generic guidelines on, it is recommended to use longer time frames of at least 5 to 20 years (Hein et al., 2008) and to apply more streams at various locations.

Secondly, in this study two, relatively extreme but simple, configurations of the HTE-system were included. The results of the HTE temperature change sensitivity analysis however, show a substantial variety in annual outcome of the model with different temperature settings. Since many more configurations are conceivable, applying several more advanced temperature reduction strategies such as mentioned by CE Delft and Deltares (2018) may be interesting. This could help generate insight for engineers to develop HTE-systems that are optimized for both positive effects on the ecology and maximum thermal energy recovery for the built environment. By application of the various verification methods in this research we ensured that the model provides results that are replicable with other cases and HTE-system configurations.

4.1.3 Results

The objective of modelling the potential effects of HTE on the stream ecology is to generate insight with which one can prevent negative effects and turn to account the opportunities for positive effects. To date no modelling study has been performed which generates results that provide insight in the potential effect of HTE on the ecology in a stream on seasonal and daily basis, in relation to the thermal energy that would come available for the built environment. The produced results in this research clearly show where the effects on the indicators are positive and where they are negative. We also see the moments of transition between these two and we get an indication of the size of the effect. Therefore the results can be used to determine the moments at which thermal energy recovery is expected to have positive effects on the ecology and at which moments thermal energy recovery should be avoided to prevent negative ecological effects. Moreover, the longitudinal range shows us the size of the part of the stream that is influenced. Which can be used as a weighing factor for the effect on the ecology. This range can also be used to determine the minimal distance between two HTE-systems to prevent thermal interaction. Although the results provide us with valuable information there are some points of attention.

part of the thermal energy solution.

Firstly, we see excessive temperature decreases with the configuration two HTE-system. This is the result of variation in the flow through the stream while the amount of extracted energy by HTE remains the same. Many practical arguments can be raised which makes this not possible. However, if the water of the stream flows through the HTE-system multiple times because the flow through the HTE-system is larger than the flow through the stream it is technically possible to lower the stream temperature in multiple steps. With this temperature decrease of more than 5 °C can be realised.

Secondly, in the winter period we see an extremely high bivalve PNOF. It is likely that this is the result of the inclusion of more bivalve species than actually are present in the Dutch waters and the Goorloop.

4.1.4 Value of conclusions

The conclusions that can be drawn from the results have value for the specific case that was analysed but also for the HTE in general. The moments in time on which the positive effects occur correspond to the advised thermal energy extraction strategy of CE Delft and Deltares (2018). This supports the conclusions that are drawn regarding the moments in time at which thermal energy should be extracted to only have positive effects on the ecology of the Goorloop. With this the amount of thermal energy that was calculated to become available for the built environment should also be a representative first estimation for this case.

The other way around, since the outcome of this research shows that positive effects on the ecology can (only) be expected in summer this supports this strategy for only extracting thermal energy in summer. This is valuable for the development of a national regulatory framework and guidelines for cold water discharge. As mentioned before however, it is recommended to, from statistical point of view, perform more and longer analysis with more ecological indicators before using the outcome of this research as generically applicable guidelines on future time frames and other streams.

4.1.5 Base for further research

Despite the discussion points the model that was developed in this research can serve as a basis for future research. Programmed in freely available and world wide supported Python code, the model can be developed further by anyone interested and involved with the sustainable application of HTE-systems. Other streams can be applied and other HTE related stressors can be implemented. Besides, the model can be expanded with other ecological indicators. The model can also be used to design the energy extraction for a certain stream HTE-system combination, in a way mostly positive effects can be expected on the investigated ecological indicators.

4.2 Conclusion

In this chapter we will describe the answer on the main research question: ‘to what extend is the ecology of a streams affected by thermal energy recovery with HTE?’

In the results we can identify moments in which the effect of HTE on the ecological indicators, and with this the ecology as a whole, is mainly positive. We can also identify moments in which the effect is mainly negative. Moreover, there are moments in which there are no effects (neutral) and were the effects vary between positive and negative. In table 10 we provide an overview of the conclusions. Thereafter, we will describe the drawn conclusions regarding the effect on the ecology and the relation with the longitudinal rang and the available energy in more detail.

Table 10: Effect of HTE on the stream ecology categorized in *Positive, Negative, Neutral and Varying*. Assigned per month from January (J) until December (D). E_{BUILT} was summed up for the particular period and has a range as a result of differences in the HTE-system configurations. Under s the minimum and the maximum longitudinal range in the particular period are depicted.

Effect	Time [Month]												E_{Built} [TJ]	s_r [km]	
	J	F	M	A	M	J	J	A	S	O	N	D			
Pos.						X	X							3.0 – 6.0	2.0 - 4.0
Neg.		X	X	X	X									6.5 – 13.0	0.5 – 10
Neu.	X								X	X	X	X		8.5 - 16.5	0.5 - 8.0
Var.						X		X						2.5 – 5.5	0.5 - 4.5

Positive are the main effects on the ecology from the second half of June until the end of July. This can be appointed to the reduction of the natural peak temperatures with HTE in this period in which all ecological indicators show positive effects. With this it can be expected that the entire ecology will benefit from the cold water discharge of HTE over a longitudinal distance between 2 and 4 km. These positive effects come with 50 up to 130 GJ of thermal energy for the built environment per day with a total between 3 and 6 TJ (100-200 household equivalent¹⁴). The latter is depend upon the configuration of HTE-system.

Negative are the main effects on the ecology from the start of February until the end of May. Although there is no effect on the thermal water quality, the fish spawning potential and the bivalve PNOF do show negative effects. Therefore, it can be expected that the ecological quality will be affected negatively in this period due to lower temperatures¹⁵. Due to a relatively high fluctuation of the flow in the stream the longitudinal range of these effects fluctuate as well,

¹⁴To help the reader to place the amount of energy in a context we also display how much households could be heated with this amount of energy. For this we assume that a typical household needs 30 GJ/year for living space heating

¹⁵If we take into account the sensitivity of the thermal water quality for the allocation of another water type the results could be interpreted more positive for this moment.

from 0.4 up to 9 *km*. With the fluctuations in the flow, the thermal energy for the built environment, that can be related to these effects, fluctuates as well. Per day from 10 up to 250 *GJ* is available. Depend on the HTE-system configuration these moments contain between 6.5 up to 13 *TJ* of thermal energy (200-400 household equivalent¹³) in total.

Neutral are the effects in the time frame from the start of September until the end of February. Although the bivalve PNOF still has negative effects, we see no effect on the thermal water quality and the fish spawning potential. The latter is the result of the temperatures that have become lower than required for the highest quality score and in this time window no fish species prefers to spawn. Therefore, we define the effects in this time frame as neutral. The longitudinal range of the thermal influence fluctuates between 0.5 and 8 *km*. The daily available thermal energy would be between 10 and 120 *GJ* and the total amount of thermal energy over the analysed period would be between 8.5 and 16.5 *TJ* (280-550 household equivalent¹³).

Varying effects are seen in the first half of June and from the end of July until the end of August. The results show both positive and negative effects on the bivalve PNOF and the fish spawning potential. In these periods the temperature is between fifteen and twenty degrees Celsius which seems to form a tipping point for the effects. On a daily basis the available energy fluctuates between 15 and 130 *GJ*. Depending on the HTE-system configuration this moment can stand for 2.5 up to 5.5 *TJ* of thermal energy (80-180 household equivalent¹³) for the built environment in total.

The generic conclusion , both for this case and HTE in general, based on the results of this research, is that cold water discharge from HTE can potentially affect the ecology of a stream both positively and negatively, depending on the time of the year. To prevent negative effects on the ecology HTE should not be applied in (late) winter¹⁶ and (early) spring. In line with the advice and assumptions of CE Delft and Deltares (2018) and de Boer et al. (2015) HTE can be applied in (early) summer to enhance positive effects on the ecology. Moreover, we see that the temperature decrease can be larger than the temperature increase resulting from global climate change (fig. 3) that we have seen to date. Specifically for the applied case the effects can have a range of several hundred meters up to several kilometers and available energy can vary significantly with the configuration of the HTE-system in combination with the flow of the stream.

¹⁶Although some see this a solution to enable popular ice skating competitions as the 'elfstedentocht' (van den Dobbelsesteen, 2019).

5 Recommendations

Based on the conclusions of this research we recommend to only extract thermal energy with HTE from streams in summer and not in winter and spring.

In the discussion several topics were mentioned that deserve extra attention. Investigating these topics could be highly valuable for both the role of HTE in the Dutch energy transition and preserving the ecosystems that provide the Dutch society with many other ecosystem services than only thermal energy. Therefore, we recommend to perform additional research based on these topics to generate more insight in the effects that cold water discharge by HTE could have on the ecology of streams with the objective of enabling, large scale but also responsible, application of HTE. The topics that deserve the most attention are:

- a) Select present bivalve species for bivalve PNOF analyses
- b) Implement more ecological indicators in model (with a.o. temperature trigger values)
- c) Implement function for present stressors in model
- d) Improve longitudinal range calculations with asymptotic recovery process
- e) Include more HTE-system setups and apply more advanced thermal energy recovery strategies
- f) Apply more streams and longer time frames as case

In this future research we strongly recommend to keep applying an interdisciplinary system approach that includes both the need of the Dutch society for sustainable and comfortable warmth and our responsibility for taking good care of the freshwater ecosystems around us.

References

- Alterra. (2007). *Klimaatverandering en aquatische biodiversiteit. Literatuurstudie naar temperatuur*. Wageningen.
- Astles, K. L., Winstanley, R. K., Harris, J. H., & Gehrke, P. C. (2003). *Regulated rivers and fisheries restoration project: Experimental study of the effects of cold water pollution on native fish* (No. 44). NSW Fisheries – Office of Conservation.
- Boderie, P., van Geest, G., & van Megchelen, C. (2018). Effecten koud water lozing slootsysteem Hoog and Dalem. Deltares 1205909-000-ZWS-0020.
- Boderie, P., & Wortelboer, R. (2018). *Effecten van thermische energie uit opperolaktewater*. Deltares 11200544-000-BGS-0002.
- Brezonik, P. L. (1994). *Chemical kinetics and process dynamics in aquatic systems*. Boca Raton, FL: CRC Press, Inc.
- CE Delft, & Deltares. (2018). *Nationaal potentieel van aquathermie*. Delft. Retrieved from <https://www.ce.nl/publicaties/download/2605>
- Chiles, J. R. (2009). The Other Renewable Energy. *Invention & Technology*, 24–35.
- Collas, F. P., Buijse, A. D., Hendriks, A. J., van der Velde, G., & Leuven, R. S. (2018). Sensitivity of native and alien freshwater bivalve species in Europe to climate-related environmental factors. *Ecosphere*, 9(5). doi: 10.1002/ecs2.2184
- de Boer, S., Scholten, B., Boderie, P., & Pothof, I. (2015). *Kansenkaart voor energie uit opperolaktewater*. Retrieved 2019-06-13, from <https://www.h2owaternetwerk.nl/vakartikelen/kansenkaart-voor-energie-uit-oppervlaktewater>
- de Graaf, R., van de Ven, F. H., Miltenburg, I. J., van Ee, B., van de Winckel, L. C., & van Wijk, G. (2008). Exploring the technical and economic feasibility of using urban water system as a sustainable energy source. *Thermal Science*, 12(4), 35–50. doi: 10.2298/TSCI0804035d
- Deltares. (n.d.). *Studying opportunities for energy from surface water*. Retrieved 2019-06-26, from <https://www.deltares.nl/en/projects/studying-opportunities-energy-surface-water/>
- Dodds, W. K., & Whiles, M. R. (2010). *Freshwater Ecology. Concepts and environmental applications of limnology* (2nd ed.). Academic Press.
- Dürrenmatt, D. J., & Wanner, O. (2014). A mathematical model to predict the effect of heat recovery on the wastewater temperature in sewers. *Water Research*, 48(1), 548–558. doi: 10.1016/j.watres.2013.10.017
- EPA. (n.d.-a). *Indicators: Conductivity*. Retrieved 2020-06-09, from <https://www.epa.gov/national-aquatic-resource-surveys/indicators-conductivity>
- EPA. (n.d.-b). *Indicators: Dissolved Oxygen*. Retrieved 2020-06-09, from <https://www.epa.gov/national-aquatic-resource-surveys/indicators-dissolved-oxygen>
- EPA. (n.d.-c). *Indicators: Fish Assemblage*. Retrieved 2020-06-09, from <https://www.epa.gov/national-aquatic-resource-surveys/indicators-fish-assemblage>
- Espelund, M., & Klaveness, D. (2014). Botulism outbreaks in natural environments - an update. *Frontiers in Microbiology*, 5(JUN), 1–7. doi:

- 10.3389/fmicb.2014.00287
- European Commission. (2019). *Introduction to the EU Water Framework Directive*. Retrieved from https://ec.europa.eu/environment/water/water-framework/info/intro{_}en.htm
- Frijns, J., Hofman, J., & Nederlof, M. (2013, jan). The potential of (waste)water as energy carrier. *Energy Conversion and Management*, 65, 357–363. doi: 10.1016/j.enconman.2012.08.023
- Hein, L., De Kraker, J., Leemans, R., Lohr, A., Metzger, M., Van Rhijn, J., & Van der Zouwen, M. (2008). *Ecosystems and Human Well-being*. Heerlen, the Netherlands: Open Universiteit Nederland.
- Idsø, J., & Årethun, T. (2017). Water-thermal energy production system: A case study from Norway. *Sustainability (Switzerland)*, 9(9), 1665. doi: 10.3390/su9091665
- IF Technology. (n.d.-a). *Hydrothermal energy*. Retrieved 2019-06-26, from <https://www.iftechnology.nl/hydrothermal-energy>
- IF Technology. (n.d.-b). *Surface Water Energy*. Retrieved 2019-06-26, from <https://www.iftechnology.com/surface-water-energy/>
- Inayat, A., & Raza, M. (2019). District cooling system via renewable energy sources: A review. *Renewable and Sustainable Energy Reviews*, 107, 360–373. doi: 10.1016/j.rser.2019.03.023
- IPBES. (2019). *Summary for policymakers of the global assessment report on biodiversity and ecosystem services – unedited advance version*. Retrieved from https://www.ipbes.net/system/tdf/spm{_}global{_}unedited{_}advance.pdf?file=1{\&}type=node{\&}id=35245
- IPCC. (2013). *Climate Change 2013: The Physical Science Basis. Contribution of Working Group I to the Fifth Assessment Report of the Intergovernmental Panel on Climate Change*. Cambridge, United Kingdom and New York, NY, USA: Cambridge University Press. Retrieved from https://www.researchgate.net/profile/Abha{_}Chhabra2/publication/271702872{_}Carbon{_}and{_}Other{_}Biogeochemical{_}Cycles/links/54cf9ce80cf24601c094a45e/Carbon-and-Other-Biogeochemical-Cycles.pdf doi: 10.1017/CBO9781107415324.Summary
- IPCC. (2018). *Global warming of 1.5C-IPCC*. Retrieved from https://report.ipcc.ch/sr15/pdf/sr15{_}spm{_}final.pdf
- Jagusztyn, T. (2011). Hydrothermal energy: Sustainable benefits for island and coastal communities. In *Ashrae's 2012 winter conference in chicago*. Retrieved from http://cotherma.com/MarineRenewableEnergy{_}HydrothermalEnergy-7Nov11{_}printedition{_}3.pdf
- KNMI. (n.d.). *Day values wheather Eindhoven measuring station*. Retrieved 2020-01-03, from <http://projects.knmi.nl/klimatologie/daggegevens/selectie.cgi>
- Knudsen, M. D., & Petersen, S. (2017). Model predictive control for demand response of domestic hot water preparation in ultra-low temperature district heating systems. *Energy and Buildings*, 146, 55–64. Retrieved from <http://dx.doi.org/10.1016/j.enbuild.2017.04.023> doi: 10.1016/j.enbuild.2017.04.023
- Lathrop, R. C., Stow, C. A., Panuska, J. C., Soranno, P. A., & Carpenter, S. R. (1998). Phosphorus loading reductions needed to control blue-green algal

- blooms in lake mendota. *Canadian Journal of Fisheries and Aquatic Sciences*, 55(5), 1169–1178. doi: 10.1139/f97-317
- Leuven, R. S., Hendriks, A. J., Huijbregts, M. A., Lenders, H. J., Matthews, J., & van der Velde, G. (2011). Differences in sensitivity of native and exotic fish species to changes in river temperature. *Current Zoology*, 57(6), 852–862. doi: 10.1093/czoolo/57.6.852
- Lugg, A., & Copeland, C. (2014, jan). Review of cold water pollution in the Murray-Darling Basin and the impacts on fish communities. *Ecological Management and Restoration*, 15(1), 71–79. doi: 10.1111/emr.12074
- Meggers, F., & Leibundgut, H. (2011, apr). The potential of wastewater heat and exergy: Decentralized high-temperature recovery with a heat pump. *Energy and Buildings*, 43(4), 879–886. doi: 10.1016/j.enbuild.2010.12.008
- Mooij, W. M., Janse, J. H., De Senerpont Domis, L. N., Hülsmann, S., & Ibelings, B. W. (2007). Predicting the effect of climate change on temperate shallow lakes with the ecosystem model PCLake. *Hydrobiologia*, 584(1), 443–454. doi: 10.1007/s10750-007-0600-2
- Netwerk Aquathermie. (2020a). *Aquathermie in de praktijk: eerste conclusies en inzichten*. Retrieved from <https://aquathermie.nl/bibliotheek/HandlerDownloadFiles.ashx?idnv=1563686>
- Netwerk Aquathermie. (2020b). *Hoe zit aquathermie in de Concept RES'en?* Retrieved from <https://aquathermie.nl/nieuws/1664421.aspx>
- Ramaker, M. (2014). *Surfacewater and technology in the fjords of Oslo*.
- RIVM. (n.d.). *Modelinstrumentarium koelwater*. Retrieved 2020, from <https://www.helpdeskwater.nl/onderwerpen/emissiebeheer/afvalwater/koelwater/modelinstrumentarium/>
- STOWA. (2011). *Een frisse blik op warmer water*. Retrieved from [http://stowa.nl/upload/publicaties/2011-20\(2\).pdf](http://stowa.nl/upload/publicaties/2011-20(2).pdf)
- STOWA. (2017a). *Ecological Key Factors: A method for setting realistic goals and implementing key factors ecological cost-effective measures for the improvement of ecological water quality*. Retrieved from <https://www.stowa.nl/sites/default/files/assets/PUBLICATIES/Publicaties2017/STOWA2017-25Eng.pdf>
- STOWA. (2017b). *Ecologische effecten koudwaterlozingen*. Retrieved from <https://www.stowa.nl/sites/default/files/assets/DELTAFACTS/DeltafactsNLPDFnieuwformat/Ecologischeeffectenkoudwaterlozingen.pdf>
- STOWA. (2018a). *Ecologische sleutelfactoren bufferzone en waterplanten*. , 28, 23.
- STOWA. (2018b). *Energie en Waterbeheer*. Retrieved from <https://www.stowa.nl/sites/default/files/assets/PUBLICATIES/Publicaties2018/2018-65EnergieenWaterbeheer.pdf>
- STOWA. (2018c). *Handreiking Aquathermie*. Retrieved from <https://www.stowa.nl/sites/default/files/assets/PUBLICATIES/Publicaties2018/STOWA2018-47handreikingaquathermie.pdf>
- STOWA. (2018d). *Referenties en maatlatten voor natuurlijke wateren voor de Kader-richtlijn Water 2015-2021*.
- Sweers, H. E. (1976). A nomogram to estimate the heat-exchange coefficient at the air-water interface as a function of wind speed and temperature; a critical survey of some literature.

- United Nations. (2016). Paris Agreement. In (p. 1). Retrieved from C.N.735 .2016.TREATIES-XXVII.7.d
- van Bussel, L. (n.d.). *Models in environmental systems analysis*. Wageningen.
- van den Dobbelaar, A. (2019). *Warmtepomp maakt Elfstedentocht mogelijk*. Retrieved from <https://www.omropfryslan.nl/nieuws/869510-professor-warmtepomp-maakt-elfstedentocht-mogelijk>
- van der Grinten, E., van Herpen, F., van Wijnen, H., Evers, C., Wuijts, S., & Verweij, W. (2007). *Afleiding maximumtemperatuurnorm goede ecologische toestand (GET) voor Nederlandse grote rivieren*. Bilthoven: RIVM. Retrieved from <http://www.rivm.nl/bibliotheek/rapporten/607800004.pdf>
- van Megchelen, C. (2017). *Cool water effects on shallow surface water* (Unpublished master's thesis). TU Delft and Deltares, Delft.
- Verbrugge, L. N., Schipper, A. M., Huijbregts, M. A., van der Velde, G., & Leuven, R. S. (2012). Sensitivity of native and non-native mollusc species to changing river water temperature and salinity. *Biological Invasions*, 14(6), 1187–1199. doi: 10.1007/s10530-011-0148-y
- Vlek, C. (2019). Rise and reduction of induced earthquakes in the Groningen gas field, 1991–2018: statistical trends, social impacts, and policy change. *Environmental Earth Sciences*, 78(3), 59. Retrieved from <https://doi.org/10.1007/s12665-019-8051-4> doi: 10.1007/s12665-019-8051-4
- Waternet. (2019). *Thermische energie*. Retrieved from <https://www.waternet.nl/innovatie/co2-reductie/thermische-energie/>
- Whitehead, P. G., Wilby, R. L., Battarbee, R. W., Kernan, M., & Wade, A. J. (2009). A review of the potential impacts of climate change on surface water quality. *Hydrological Sciences Journal*, 54(1), 101–121. doi: 10.1623/hysj.54.1.101
- Wortelboer, R. (2018). *Aanvulling berekeningen effecten van thermische energie uit oppervlaktewater*. Deltares 11202197-008-BGS-0001.

APPENDIX

A Future development of global temperature

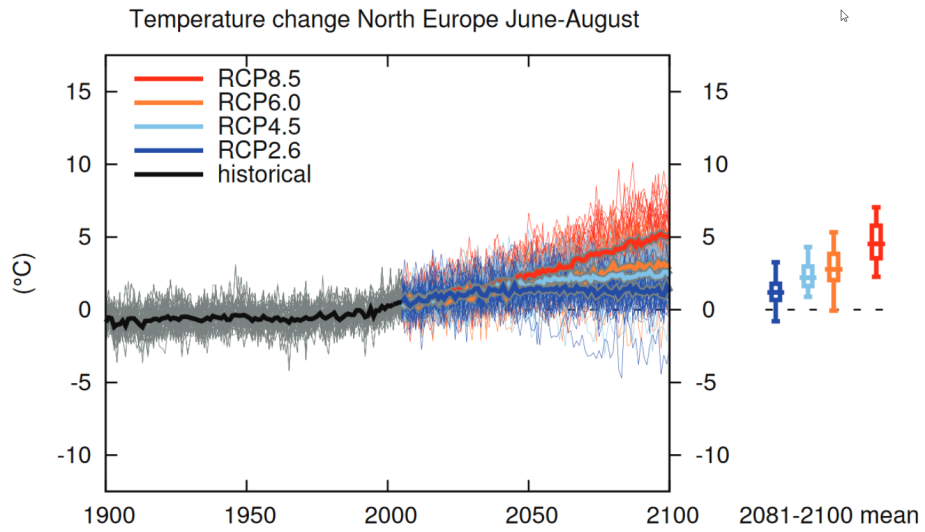

Figure 26: Predicted temperature change for North Europe from June till August (IPCC, 2013)

B Water types according to the WFD

Water types according to the WFD. Water types relevant for this research are: R4, R19, R5, R6, R7, R12, R20

Categorie	TypeCode	TypeNaam
Meren	M12	Kleine ondiepe zwak gebufferde plassen (vennen)
Meren	M14	Ondiepe gebufferde plassen
Meren	M20	Matig grote diepe gebufferde meren
Meren	M21	Grote diepe gebufferde meren
Meren	M23	Grote ondiepe kalkrijke plassen
Meren	M27	Matig grote ondiepe laagveenplassen
Meren	M30	Zwak brakke wateren
Meren	M31	Kleine brakke tot zoute wateren
Meren	M32	Grote brakke tot zoute meren
Rivieren	R4	Permanent langzaamstromende bovenloop op zand
Rivieren	R5	Langzaam stromende middenloop/benedenloop op zand
Rivieren	R6	Langzaam stromend riviertje op zand/klei
Rivieren	R7	Langzaam stromende rivier/nevengeul op zand/klei
Rivieren	R8	Zoet getijdenwater (uitlopers rivier) op zand/klei
Rivieren	R12	Langzaam stromende middenloop/benedenloop op veenbodem
Rivieren	R13	Snelstromende bovenloop op zand
Rivieren	R14	Snelstromende middenloop/benedenloop op zand
Rivieren	R15	Snelstromend riviertje op kiezelhoudende bodem
Rivieren	R16	Snelstromende rivier/nevengeul op zandbodem of grind
Rivieren	R17	Snelstromende bovenloop op kalkhoudende bodem
Rivieren	R18	Snelstromende middenloop/benedenloop op kalkhoudende bodem
Rivieren	R19	Doorstrommoeras
Rivieren	R20	Moerasbeek
Overgangswateren	O2	Estuarium met matig getijverschil
Kustwateren	K1	Kustwater, open en polyhalien
Kustwateren	K2	Kustwater, beschut en polyhalien
Kustwateren	K3	Kustwater, open en euhalien

C Relation between research questions and method

RESEARCH QUESTION TREE

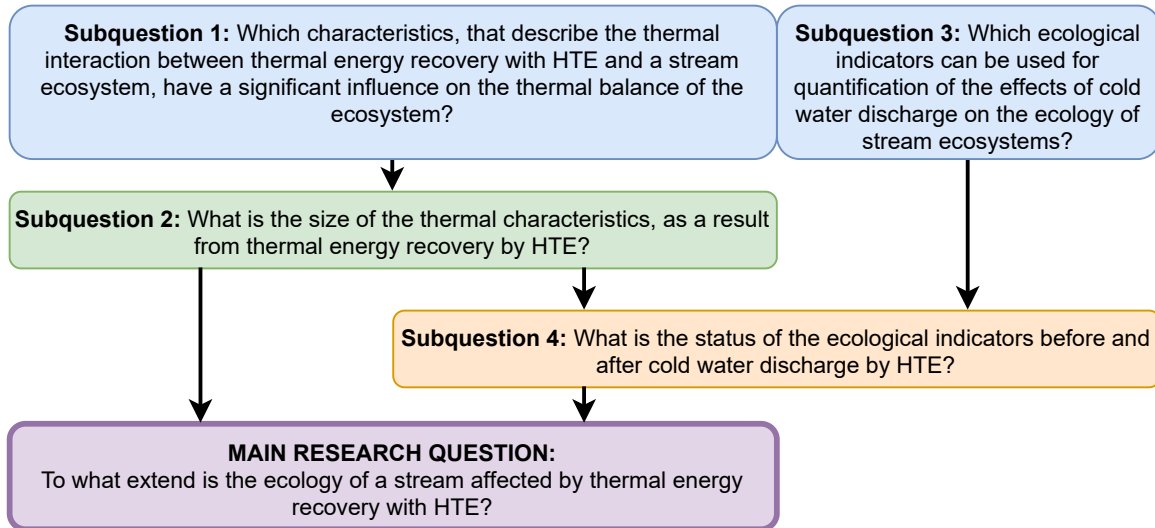

METHOD DIAGRAM

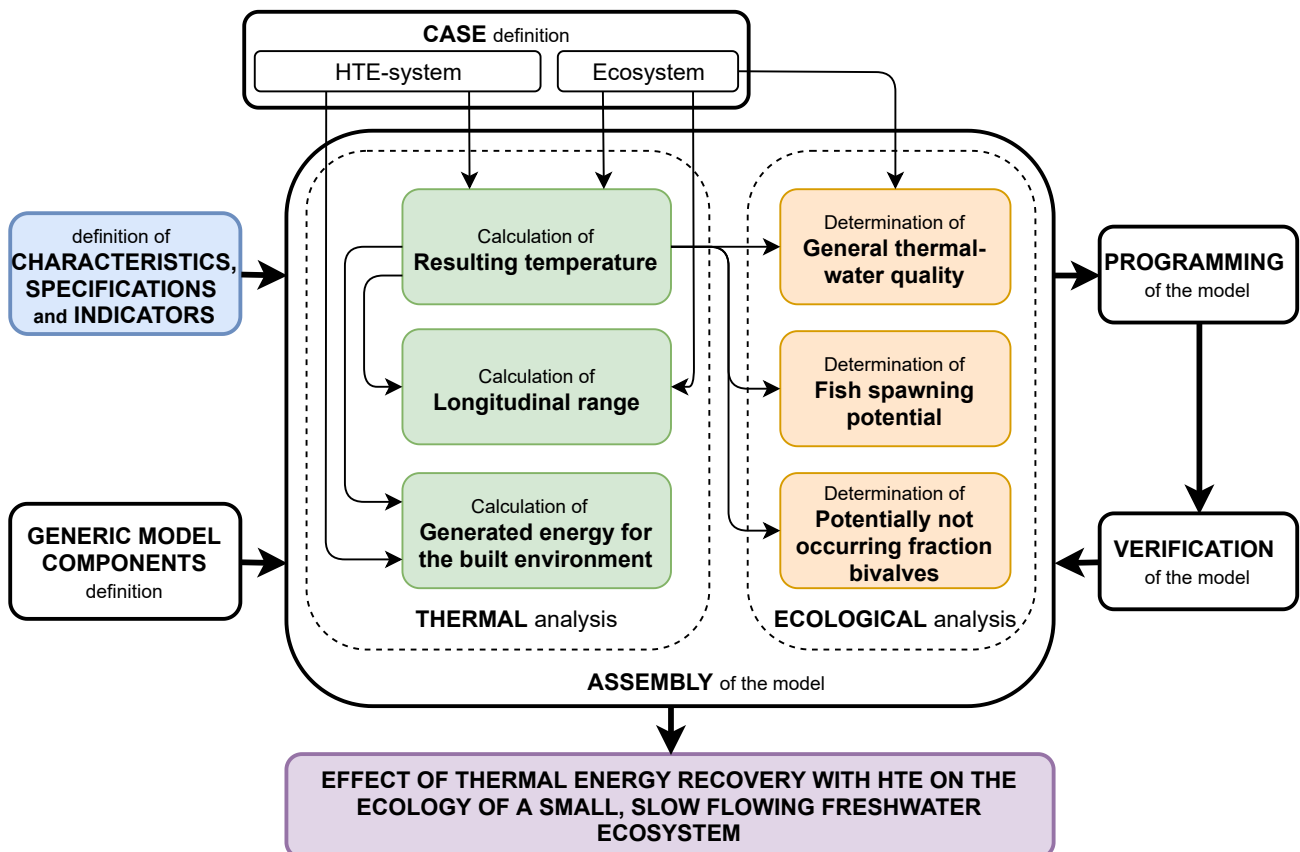

D Spawning temperatures and moments

Overview of spawning temperatures and moments of freshwater fish species that are expected to spawn in Dutch freshwater ecosystems

Fish species name Dutch	Fish species scientific name	Spawning expected temp		Max. temp	Jan.	Feb.	Mar.	Apr.	May	Jun.	Jul.	Aug.	Sep.	Oct.	Nov.	Dec.
		Min.	Max.													
Kolblei	<i>Abramis bjoerlina</i>	No	14	25												
Brasem	<i>Abramis brama</i>	No	12	23				12-23	12-23	12-23	12-23					
Atlantische steur	<i>Acipenser sturio</i>	No	21	21					21	21	21					
Gestippelde alver	<i>Alburnoides bipunctatus</i>	No	12	24					12-24	12-24	12-24					
Alver	<i>Alburnus alburnus</i>	No	14	28					14-28	14-28	14-28					
Bermplje	<i>Barbatula barbatula</i>	Yes	14	20					14-20	14-20	14-20					
Barbeel	<i>Barbus barbus</i>	No	8	29					8-29	8-29	8-29					
Giebel	<i>Carassius auratus gibelio</i>	No	15	24					15-24	15-24	15-24					
Kroeskaper	<i>Carassius carassius</i>	No	14	22					14-22	14-22	14-22					
Sneep	<i>Chondrostoma nasus</i>	No	7	16					7-16	7-16	7-16					
Kleine modderkruiper	<i>Cobitis taenia</i>	No	18	26					18-26	18-26	18-26					
Houting	<i>Congonius oxyrinchus</i>	No	5	7												
Rivierdonderpad	<i>Cottus gobio</i>	Yes	7	14					7-14	7-14	7-14				5-7	5-7
Karper	<i>Cyprinus carpio</i>	No	12	30					12-30	12-30	12-30					
Snoek	<i>Esox lucius</i>	Yes	0	23					0-23	0-23	0-23					
Driedoornige stekelbaars	<i>Gasterosteus aculeatus</i>	Yes	5	20					5-20	5-20	5-20					
Riviergrondel	<i>Gobio gobio</i>	Yes	12	17					12-17	12-17	12-17					
Pos	<i>Gymnocephalus cernuus</i>	No	6	18					6-18	6-18	6-18					
Rivierprik	<i>Lampetra fluviatilis</i>	No	5,5	<					>8,5							
Beekprik	<i>Lampetra planeri</i>	No	10	15					10-15	10-15	10-15					
Vetle	<i>Leucaspis delmeatus</i>	Yes	16	25					16-25	16-25	16-25					
Kopvoorn	<i>Leuciscus cephalus</i>	No	12	20					12-20	12-20	12-20					
Winde	<i>Leuciscus idus</i>	No	4	15					4-15	4-15	4-15					
Serpelling	<i>Leuciscus leuciscus</i>	Yes	5	14					5-14	5-14	5-14					
Kivabaal	<i>Lota lota</i>	No	0	8					0-8	0-8	0-8				0-8	0-8
Grote modderkruiper	<i>Misgurnus fossilis</i>	No	13	24					13-24	13-24	13-24					
Spierring	<i>Osmerus eperlanus</i>	No	4	12					4-12	4-12	4-12					
Baars	<i>Percu fluviatilis</i>	Yes	5	19					5-19	5-19	5-19					
Zeeprik	<i>Petromyzon marinus</i>	No	25	25					7-22	7-22	7-22					
Elrits	<i>Phoxinus phoxinus</i>	No	7	22					7-22	7-22	7-22					
Blitervoorn	<i>Rhodeus sericeus</i>	No	14	20					14-20	14-20	14-20					
Blankvoorn	<i>Rutilus rutilus</i>	Yes	8	22					8-22	8-22	8-22					
Atlantische zaim	<i>Salmo salar</i>	No	0	8					0-8	0-8	0-8				0-8	0-8
Beekforel	<i>Salmo trutta</i>	No	1	13					1-13	1-13	1-13				1-13	1-13
Zeeforel	<i>Salmo trutta</i>	No	1	8					1-8	1-8	1-8				1-8	1-8
Snoekbaars	<i>Sander lucioperca</i>	No	8	22					8-22	8-22	8-22					
Ruisvoorn	<i>Scardinius erythrophthalmus</i>	Yes	14	28					14-28	14-28	14-28					
Europese meerval	<i>Silurus glanis</i>	No	18	20					18-20	18-20	18-20					
Vlaegzaim	<i>Thymallus thymallus</i>	No	6	15					6-15	6-15	6-15					
Zeeit	<i>Tinca tinca</i>	Yes	16	32					16-32	16-32	16-32					

E Weather station Eindhoven properties

Overview of the properties of the weather station located in Eindhoven which was used for deriving air data at the position of the case.

06370 Eindhoven	
Positie:	51° 27' N.B. 05° 23' O.L.
Terreinhoogte:	20,69 meter t.o.v. NAP.
Startdatum:	19510101
Karakteristiek omgeving:	Gelegen in half open landschap, bos en heide afgewisseld door gras- en bouwland. Vliegveld
Grondsoort:	Zand
Hoogte barometer:	+22,41 meter t.o.v.NAP.
Hoogte windmeetmast:	10 meter
Visuele waarnemingen:	Stopdatum 20041126, 08:00 UT
Temperatuurmetingen:	1,5 m, gemeten m.b.v. :
19510101 - 19580912	Thermograaf in Stevensonhut (op 2,20 meter boven maaiveld)
19580912 - 19840621	Thermograaf in Stevensonhut (op 1,50 meter boven maaiveld), nieuw waarneemterrein 100 m naar het zuiden verplaatst.
19840622 - 19920915	Weerstandsmeting in Stevensonhut Brown recorder (op 1,50 meter boven maaiveld)
19921001 - heden	AWS, elektronische sensor in schotelhut (op 1,50 meter)
19921001	Instrumentverplaatsing, 80 m.
Temperatuurmetingen:	0,1 m, gemeten m.b.v. :
19710101 - 19920930	Minimumthermometer in 10 cm behuizing
19921001 - heden	AWS, elektronische sensor in schotelhut
19921001	Instrumentverplaatsing, 80 m.
Neerslagmetingen:	gemeten m.b.v. :
19710101 - 19921001	Pluviograaf (vangoppervlak 2 dm ² op 0,40 meter boven maaiveld)
19921001 - heden	Elektrische meting (Engelse opstelling)
19921001	Instrumentverplaatsing, 80 m.
Luchtdrukmetingen:	herleid naar NAP en gemeten m.b.v. :
19510101 - 19930627	Barograaf en kwikbarometer
19930628- heden	Paroscientific barometer in kast aan windmast
Windmetingen:	gemeten m.b.v., bijzonderheden en meethoogte:
19510101 - 19581017	Dynamo-anemometer KLU, geen recorder, werd uurlijks afgelezen (mA-meters). Opgesteld op schoorsteen stationsgebouw ca. 12 m.
19581017 - 19840621	Cup anemometer; met Van Doorn recorder, nieuwe mast geplaatst op ca 200 m. van de meteo. Meethoogte 10 m.
19840621 - 19920906	Idem; Camille Bauer recorder. Meethoogte 10 m.
19920906 - heden	Idem; AWS (digitale registratie). Meethoogte 10,0 m.
Vochtmetingen:	gemeten m.b.v. :
19710101 - 19940106	Droge/natte bolthermometer, later met hygromer
19940701- heden	Vaisala sensor in schotelhut
19921001	Instrumentverplaatsing, 80 m.
Stralingsmetingen:	gemeten m.b.v. :
19840701 - 19920930	????
19921001 - heden	CM11 sensor. Meethoogte 1,5 m.
Zonneschijnduur:	gemeten m.b.v. :
19780101 - 19930101	Campbell-Stokes registratie Zonneschijnduur wordt ook bepaald uit globale straling.
Zichtmetingen:	gemeten m.b.v. :
19550101 - 2007	HSS zichtsensoren
2007 - heden	PWS sensor (FD12P). Meethoogte 2,5 m.
Wolkenmetingen:	gemeten m.b.v. :
19510101 - 2007	Ceilometer (CT12K)
2007 - heden	Wolkenhoogtemeter (LD40)

F Case data ecosystem



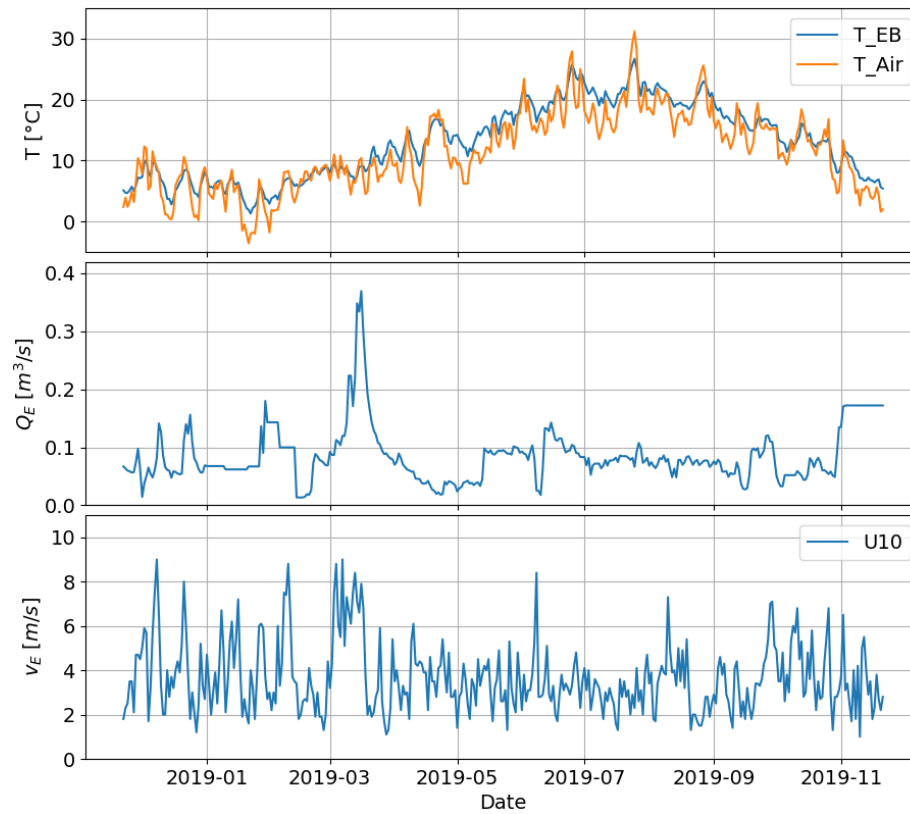

The case specific data of the Goorloop that was used as an input for the programmed model. From top to bottom: the temperature data for the ecosystem (T_{EB}) and the air (T_{Air}); the flow data of the ecosystem (Q_E); the wind speed (U_{10}).



G Communicative Model

The communicative model is composed out of the standard building blocks depicted in table 11 and will be explained further below.

Table 11: Symbols for model components, modified from van Bussel (n.d.)

Model elements	Symbol
Input element Output elements Driving forces	
Conversion	
Interaction	
Quantifying data	

Input elements are all elements or parameters that are used for performing a calculation (conversion) in the model. These determine the base for all calculations that will be performed in the model and can be seen as primary elements.

Driving forces are the input elements that can and will be changed in the model, and herewith introduce a change in the thermal and ecological outcome of the model.

Conversions are the equations that describe how input elements correspond to each other. More than one input element may serve as input for a conversion.

Output elements are generated by a conversion of the input elements. This output element may serve as an input element again for a subsequent conversion. These may be called intermediate output elements or secondary input elements. The final output elements describe the effects of the changes in thermal regime on aspects of the ecological quality of the stream ecosystem at hand.

Interaction describes the direct link of an element, driving force or conversion with a subsequent conversion.

Quantifying data includes all data that are required for quantifying the primary input elements. The data is derived from multiple sources and eventually converted to quantified ecological effects.

Thermal Analysis - Resulting temperature

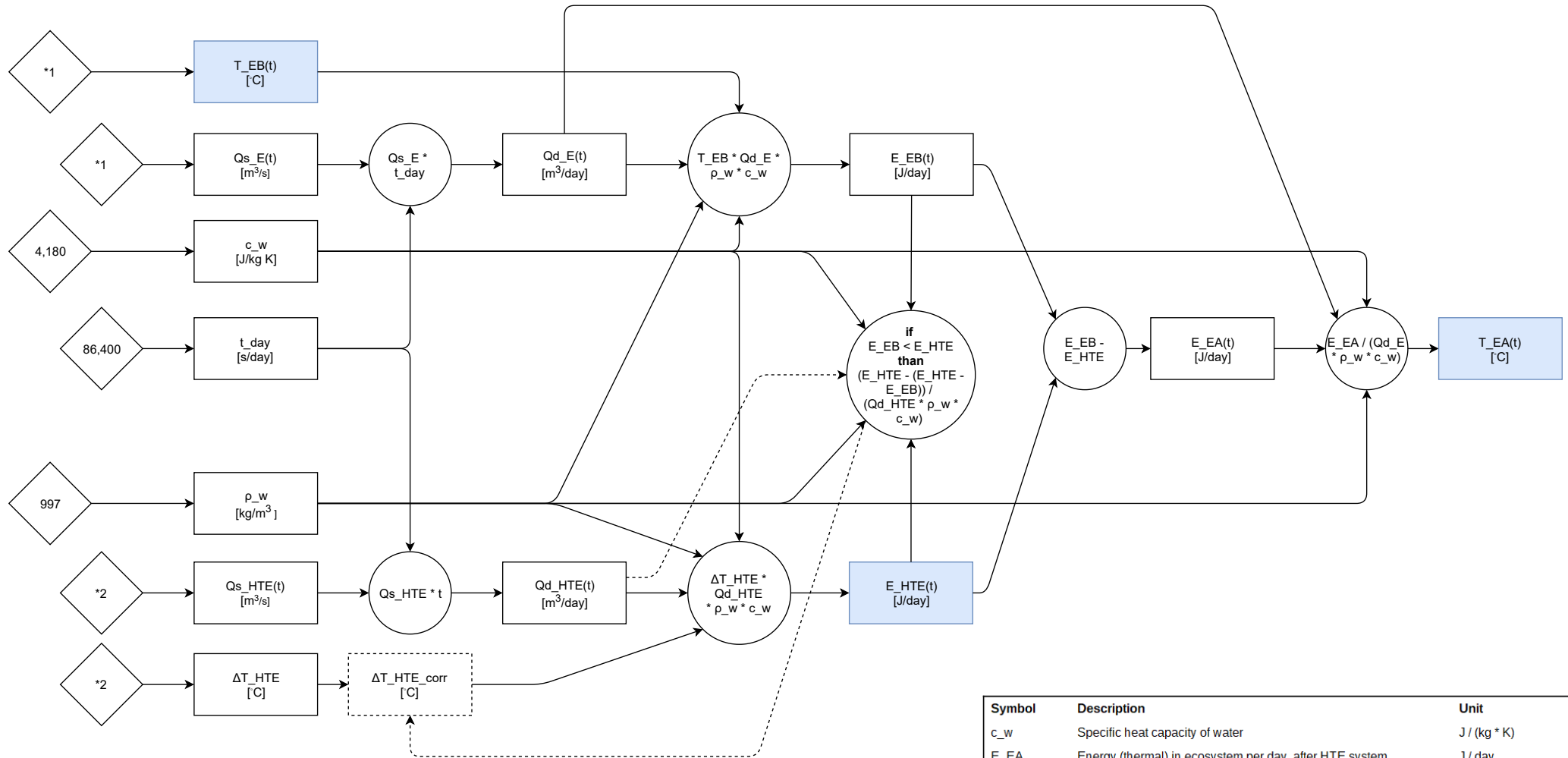

*1: Historical data from water authority
 *2: HTE project data
 *3: Historical data from KNMI

Symbol	Description	Unit
c_w	Specific heat capacity of water	J / (kg * K)
E_{EA}	Energy (thermal) in ecosystem per day, after HTE system	J / day
E_{EB}	Energy (thermal) in ecosystem per day, before HTE system	J / day
E_{HTE}	Energy (thermal) in HTE system per day	J / day
Qd_E	Water flow through the ecosystem per day	m ³ /day
Qd_{HTE}	Water flow through the HTE system per day	m ³ /day
Qs_E	Water flow in ecosystem	m ³ /s
Qs_{HTE}	Water flow through HTE system	m ³ /s
t	Time	day
t_{day}	Seconds in a day	sec.
T_{EA}	Temperature of ecosystem after HTE system	°C
T_{EB}	Temperature of ecosystem before HTE system	°C
ΔT_{HTE}	Delta temperature in HTE system	°C
λ	Heat exchange coefficient	-
ρ_w	Density of water	kg/m ³

Thermal Analysis - Longitudinal range of thermal influence

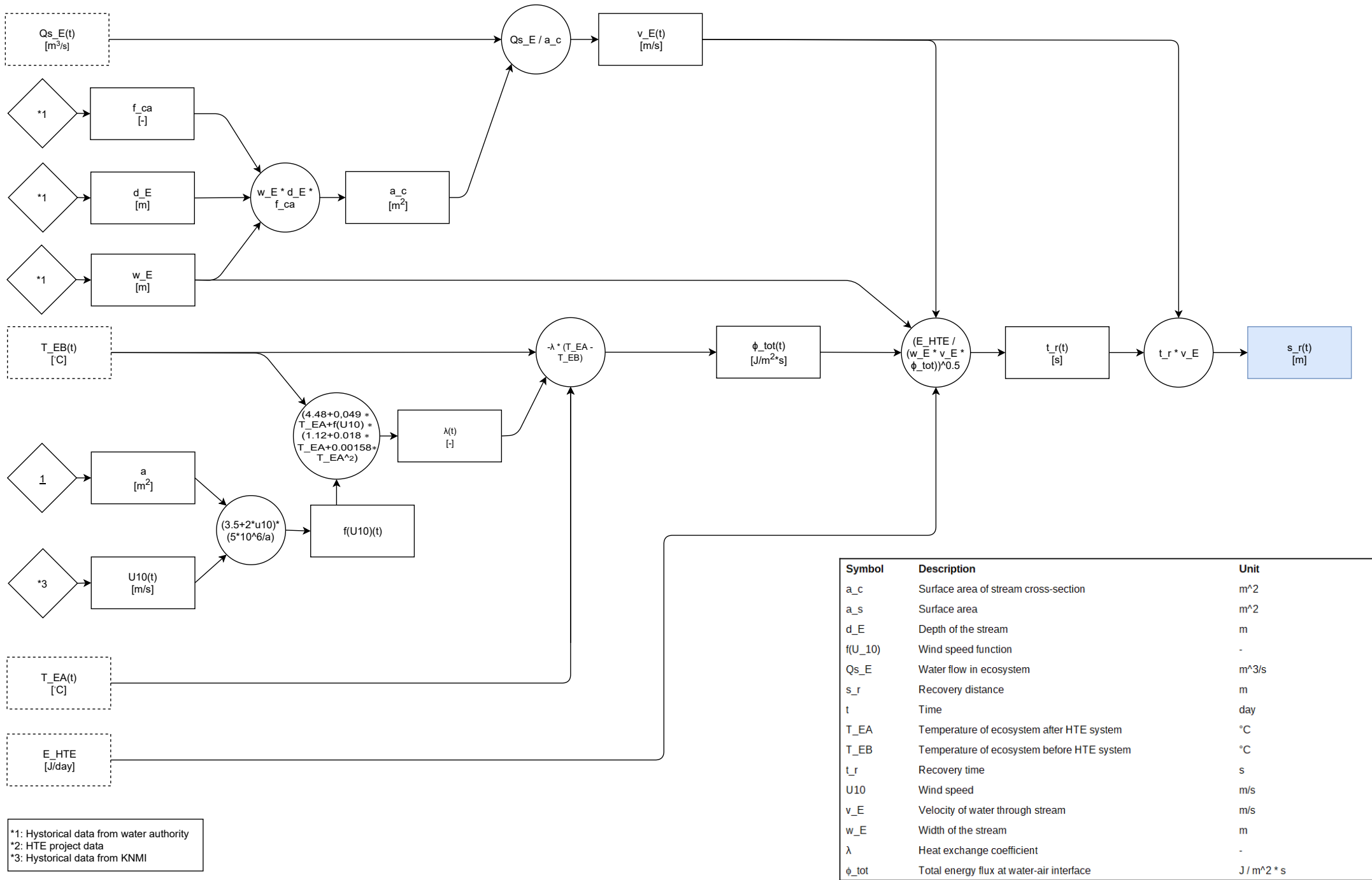

Thermal analysis - Available energy for built environment

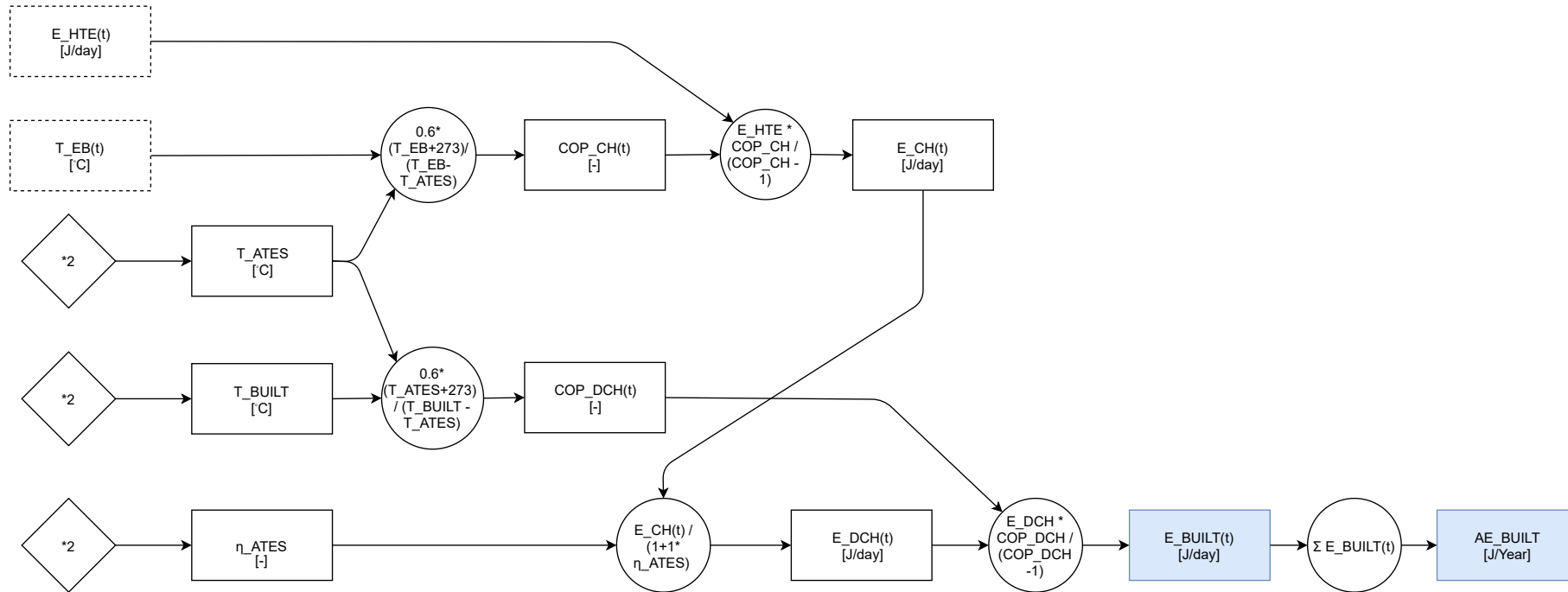

*1: Historical data from water authority
 *2: HTE project data
 *3: Historical data from KNMI

Symbol	Description	Unit
COP_CH	Coefficient of Performance of the heatpump for ATES charging	-
COP_DCH	Coefficient of Performance of the heatpump for ATES discharging	-
E_CH	Energy (thermal) with which the ATES is charged per day	J / day
E_DCH	Energy (thermal) with which the ATES is discharged per day	J / day
E_HTE	Energy (thermal) in HTE system per day	J / day
AE_BUILT	Annual Energy (thermal) available for Built environment	J / year
E_BUILT	Energy (thermal) available for Built environment	J / day
t	Time	day
T_ATES	Temperature of ATES	°C
T_BUILT	Temperature of Built environment	°C
T_EB	Temperature of ecosystem before HTE system	°C
η_{ATES}	Efficiency of ATES	%

Ecological Analyses - Thermal water quality score

Table 3: General water quality related to water temperature [°C], supplied with a quality score and divided over WFD water types that comply with our definition of a stream. Modified from (STOWA, 2018d)

Water type	Water quality				
	Very good	Good	Moderate	Insufficient	Poor
R4, R19	<14	<18	18-20	20-22.5	>22.5
R5, R6, R7, R12, R20	<23	<25	25-27.5	27.5-30	>30
Score [QSP]	4	3	2	1	0

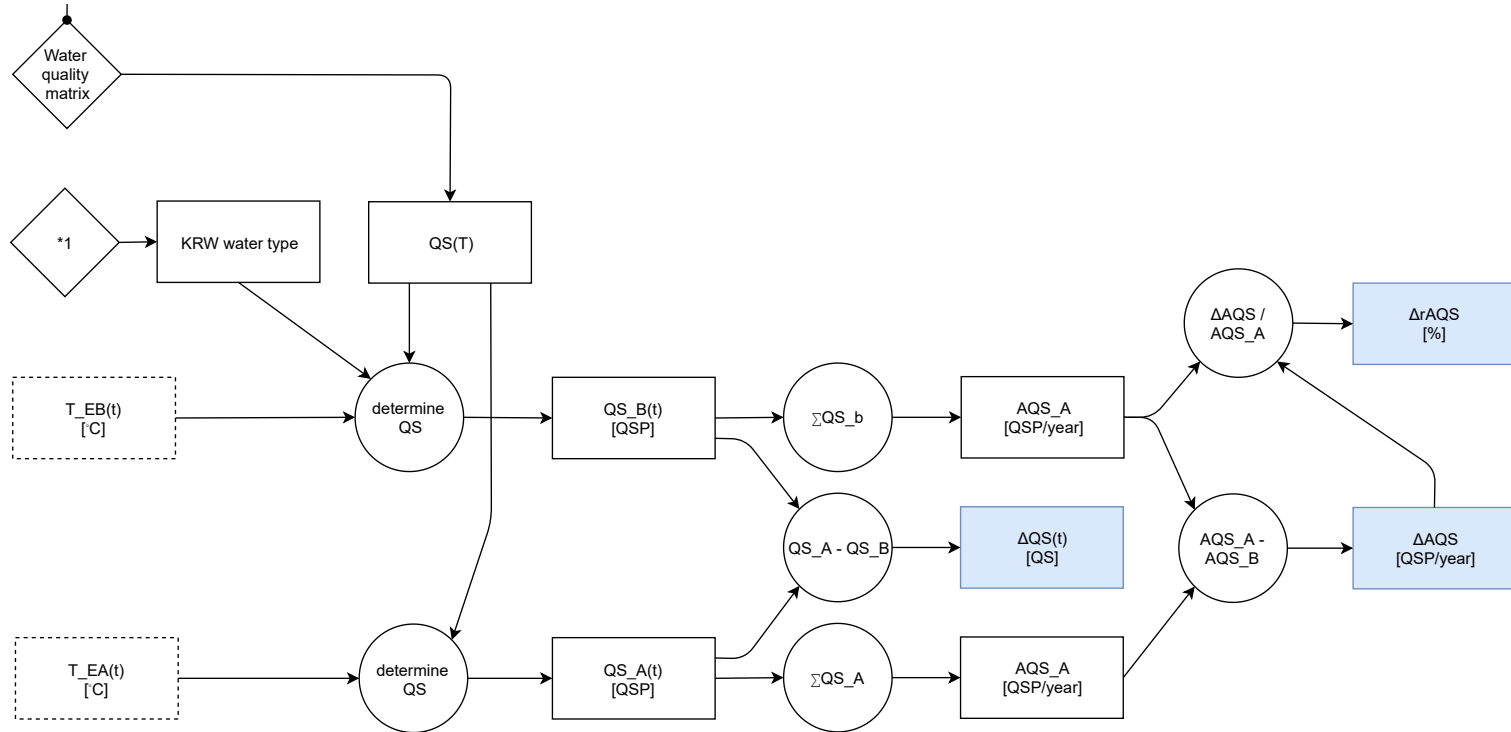

*1: Historical data from water authority
 *2: HTE project data
 *3: Historical data from KNMI

Symbol	Description	Unit
AQS_A	Annual quality score after HTE	QSP/year
AQS_B	Annual quality score before HTE	QSP/year
QS	Water quality score	QSP
QS_A	Water Quality Score after HTE	QSP
QS_B	Water Quality Score before HTE	QSP
t	Time	day
T	Temperature	°C
T_EA	Temperature of ecosystem after HTE	°C
T_EB	Temperature of ecosystem before HTE	°C
ΔAQS	Annual quality score effect	QSP/year
ΔQS	Quality score effect	QSP

Ecological Analyses - Fish Spawning Potential

Fish species name Dutch	Fish species scientific name	Spawning expected	Min. temp	Max. temp	Jan.	Feb.	Mar.	Apr.	May	Jun.	Jul.	Aug.	Sep.	Oct.	Nov.	Dec.
Kolblei	<i>Abramis bjoerkna</i>	No	14	25					14-25	14-25						
Brasem	<i>Abramis brama</i>	No	12	23				12-23	12-23	12-23	12-23					
Atlantische steur	<i>Acipenser sturio</i>	No	21	21				21	21	21	21	21				
Gestippelde alver	<i>Alburnoides bipunctatus</i>	No	12	24				12-24	12-24	12-24						
Alver	<i>Alburnus alburnus</i>	No	14	28				14-28	14-28	14-28	14-28					
Bermpje	<i>Barbatula barbatula</i>	Yes	14	20				14-20	14-20	14-20						
Barbeel	<i>Barbus barbus</i>	No	8	29				8-29	8-29	8-29	8-29					
Giebel	<i>Carassius auratus gibelio</i>	No	15	24				15-24	15-24	15-24	15-24	15-24	15-24			
Kroeskarpere	<i>Carassius carassius</i>	No	14	22				14-22	14-22	14-22	14-22					
Sneep	<i>Chondrostoma nasus</i>	No	7	16				7-16	7-16	7-16						
Kleine modderkruiper	<i>Cobetis taenia</i>	No	18	26				18-26	18-26	18-26	18-26					
Houting	<i>Coregonus oxyrinchus</i>	No	5	7										5-7	5-7	

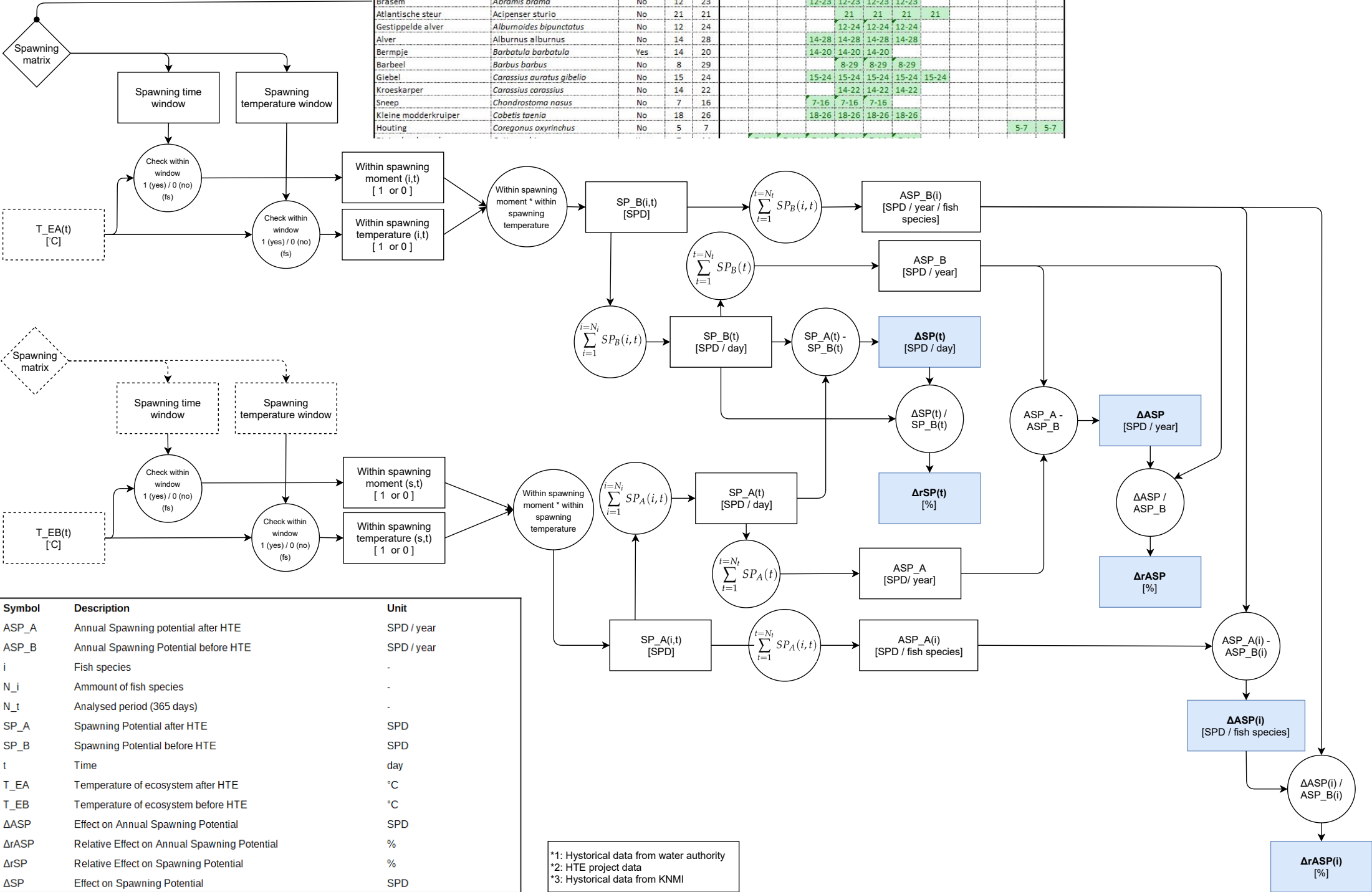

H Lambda results

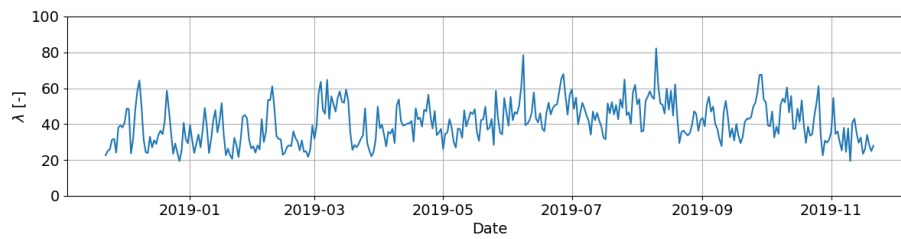

Figure 27: Lambda for the configuration one HTE-system

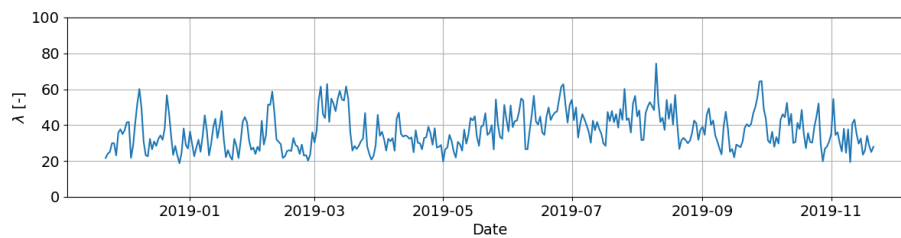

Figure 28: Lambda for the configuration two HTE-system

I Temperature sensitivity analysis results

Since the temperature influence is the most important parameter of this research we performed a sensitivity analysis on the dependency of the size of thermal influence and the ecological indicators for fluctuations in the temperature change in the HTE-system. In this analysis we applied both HTE-system configurations. The results are depicted in respectively figure 29 and 30.

I.1 Size of thermal influence

The subtracted thermal energy and the available energy for the built environment displays a linear correlation with temperature change in the HTE-system. The differences in absolute values can be accounted to the difference in the flows of the HTE-system configurations. The sensitivity of the longitudinal range for changes in the HTE temperature influence is relatively small and linear. The spike between $+1^{\circ}\text{C}$ and -1°C shows that the linear approach for determining the longitudinal range is not ideal.

I.2 Thermal water quality score

The dependency of the annual thermal water quality score with the temperature change in the HTE-system shows an exponential declining course with increasing temperatures with both configurations. The score will reach 1460 at -7°C with configuration one and at -3°C with configuration two. We can conclude that the thermal water quality part of the model is not very sensitive for a variation in temperature decrease. However, when temperature increases it is quit sensitive.

I.3 Fish spawning potential

The sensitivity of the annual fish spawning potential for the temperature difference through HTE is significantly lower in the case of configuration one compared to configuration two. Furthermore, the fish spawning potential has a declining trend around the temperature change of -3°C with configuration one. Cooling further but also cooling less and heating up results in a declining fish spawning potential. This decline has no dramatic course the differences remain within a band with of about 10%. Configuration two however, has its tipping point around 0°C and the decline of the fish spawning potential is quit dramatic in both directions and has a bandwidth of around 50%.

I.4 Bivalve PNOF

The sensitivity of the annual average bivalve PNOF for temperature change in the HTE-system is significant. In the case of configuration one we see an incline of about 50% between 0°C and -7°C . When the temperature increases

we see a decline (which is positive from ecology point of view) of not more than 15%. With configuration two we see a larger sensitivity. Between a temperature change of 0 and $-7\text{ }^{\circ}\text{C}$ the annual average PNOF increases with approximately 150%. When the temperature increases we see almost no change in PNOF up to $3\text{ }^{\circ}\text{C}$. However, between a 3 and $7\text{ }^{\circ}\text{C}$ increase the PNOF increases again with up to 60 %.

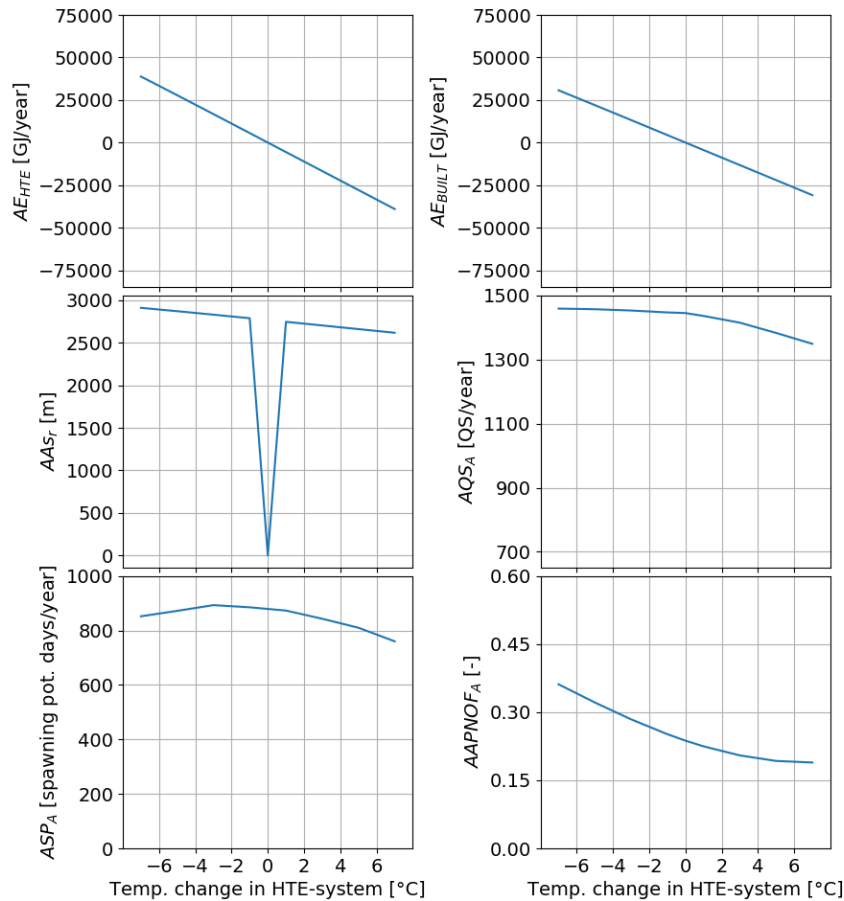

Figure 29: Annual sensitivity of size of thermal influence and ecological indicators for the temperature change of the water that flows through the **configuration one HTE-system**. From left to right and from top to bottom: thermal energy annually extracted from the stream (AE_{HTE}); thermal energy annually available for the built environment (AE_{BUILT}); annual average of the longitudinal range of the thermal influence (AAs_r); annual thermal water quality score after HTE (AQS_A); annual fish spawning potential after HTE (ASP_A); annual average of the potentially not occurring fraction of the bivalves after HTE ($AAPNOF_A$).

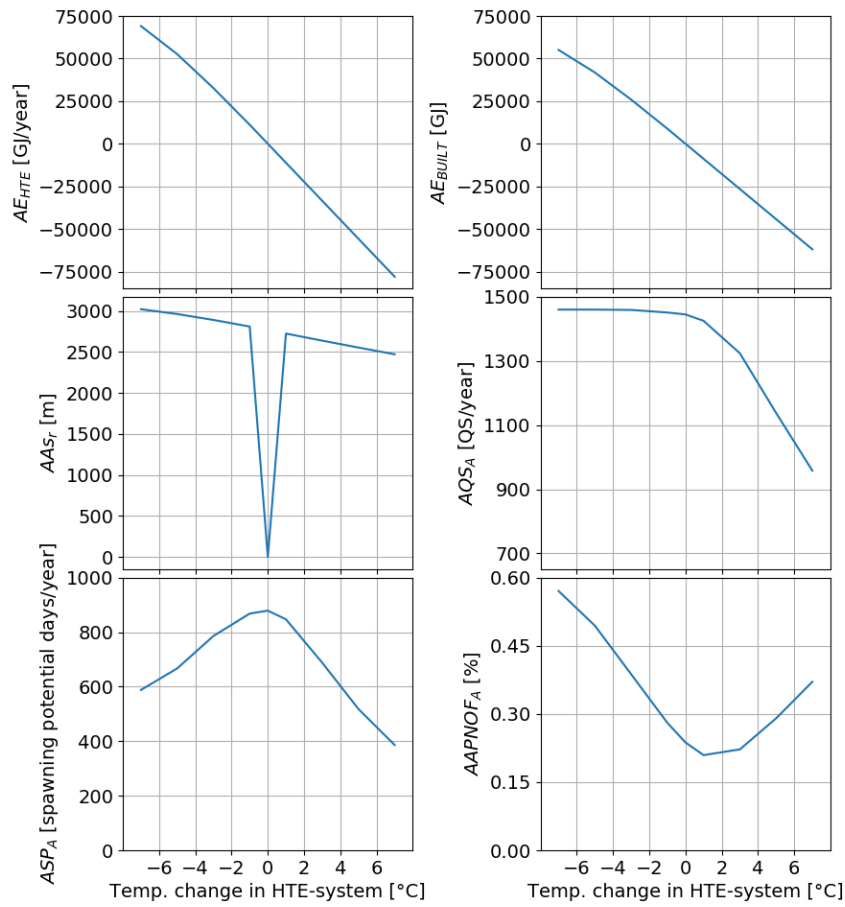

Figure 30: Annual sensitivity of size of thermal influence and ecological indicators for the temperature change of the water that flows through the **configuration two HTE-system**. From left to right and from top to bottom: thermal energy annually extracted from the stream (AE_{HTE}); thermal energy annually available for the built environment (AE_{BUILT}); annual average of the longitudinal range of the thermal influence (AAs_r); annual thermal water quality score after HTE (AQS_A); annual fish spawning potential after HTE (ASP_A); annual average of the potentially not occurring fraction of bivalves after HTE ($AAPNOF_A$).

Glossary

ATES Aquifer Thermal Energy Storage.

BTES Borehole Thermal Energy Storage.

Built environment houses and utilities.

COP Coefficient of Performance.

Ecological indicator An ecological indicator represents the state or trend of certain ecological condition over a given area and/or period of time.

Ecology interactions among organisms and their biophysical environment.

Ecosystem all living and nonliving community constituents (Dodds & Whiles, 2010).

GHG Greenhouse Gas.

HTE Hydro-Thermal Energy.

IPBES Intergovernmental Science-Policy Platform on Biodiversity and Ecosystem Services.

IPCC Intergovernmental Panel on Climate Change.

KNMI Koninklijk Nederlands Meteorologisch Instituut (Royal Netherlands Meteorological Institute).

PNOF Potentially not Occurring Fraction.

Recovery in the context of thermal energy recovery, it is the process of extraction of thermal energy from a stream; in the context of longitudinal range determination, recovery is the process towards a restored thermal balance in the stream.

SSD Specie Sensitivity Distribution.

Stream small, slow flowing, fresh surface water ecosystem.

Thermal pollution anthropogenic discharge of warm or cold water that influences the natural thermal balance of a water ecosystem both positively (temperature increase) and negatively (temperature decrease).

WFD EU Water Framework Directive (in Dutch: Kader Richtlijn Water) is a European Water Policy for protection of water with the objective to get polluted waters clean and ensure clean waters are kept clean. (European Commission, 2019).

The picture on the cover of this thesis was made in the Indre Oslofjord, from a ferry that approaches Oslo in the early morning of the 19th of August 2014 (Ramaker, 2014).

